

Organizational Charts



[Faculty of Business and Information Technology](#)
[Faculty of Education](#)
[Faculty of Energy Systems and Nuclear Science](#)
[Faculty of Engineering and Applied Science](#)
[Faculty of Health Science](#)
[Faculty of Science](#)
[Faculty of Social Science and Humanities](#)

[Advancement Office and Alumni Relations](#)
[Automotive Centre of Excellence](#)
[Finance](#)
[Human Resources](#)
[Information Technology Services](#)
[Library Services](#)
[Office of Campus Infrastructure and Sustainability](#)
[Office of Planning and Analysis](#)
[Office of the Deputy Provost](#)
[Office of Student Life](#)
[Office of the President](#)
[Communications and Marketing](#)
[Office of the Provost and Vice President, Academic](#)
[Office of the Registrar](#)
[Office of the Vice President Administration](#)
[Office of Vice-President, Research, & Innovation](#)
[School of Graduate and Postdoctoral Studies](#)
[General Counsel](#)

Faculty of Business & Information Technology

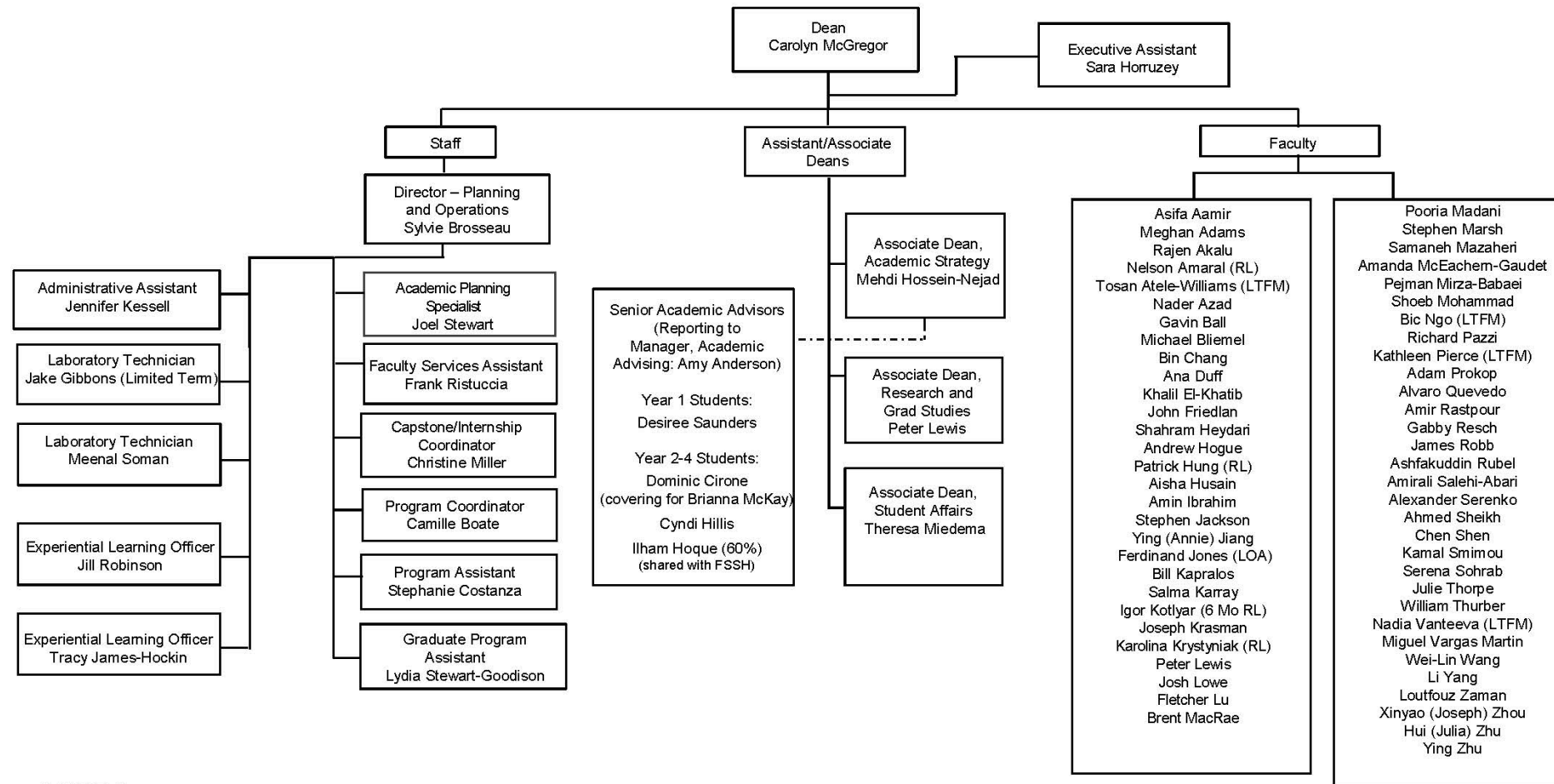

Faculty of Education

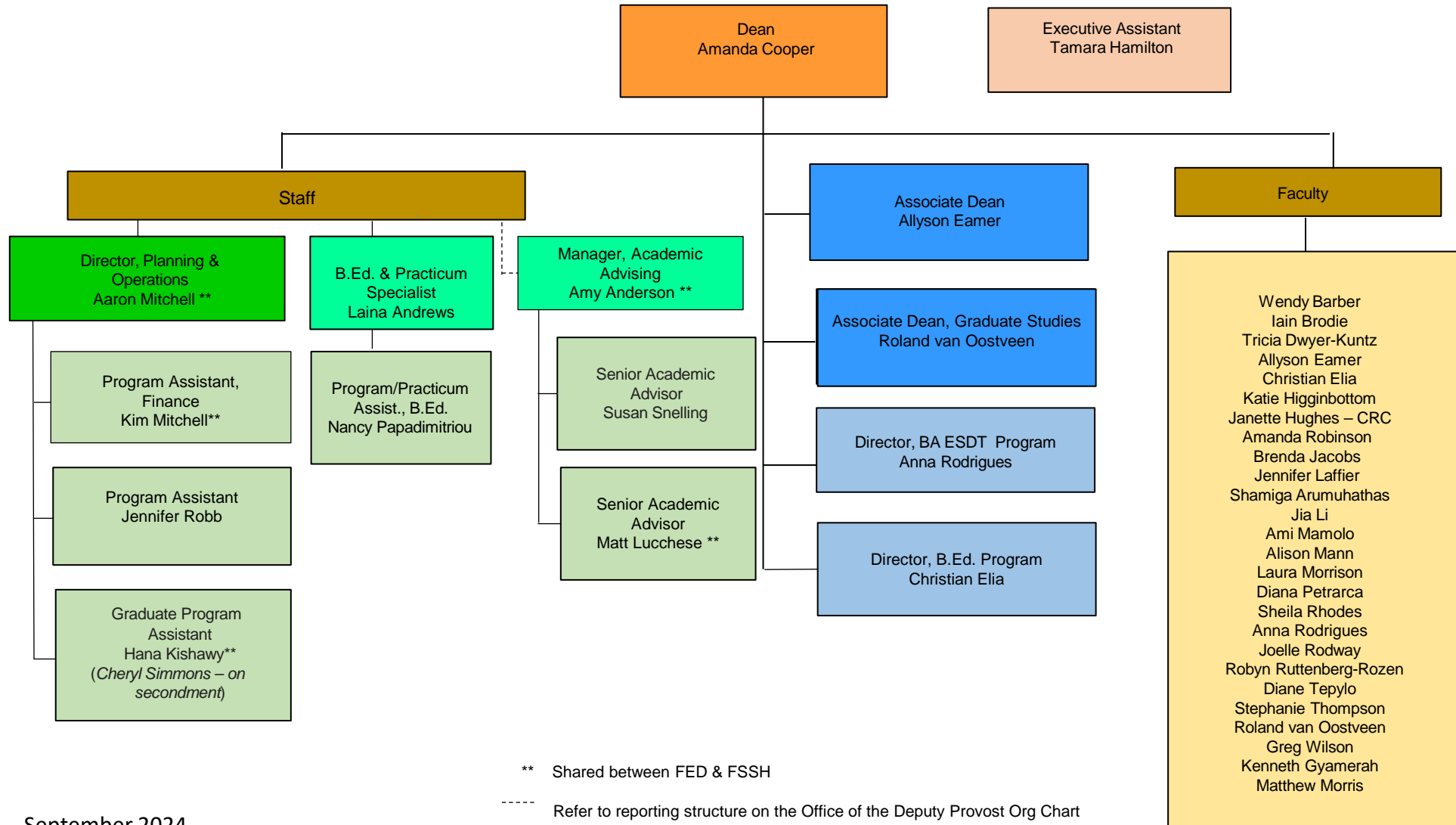

Faculty of Engineering & Applied Science

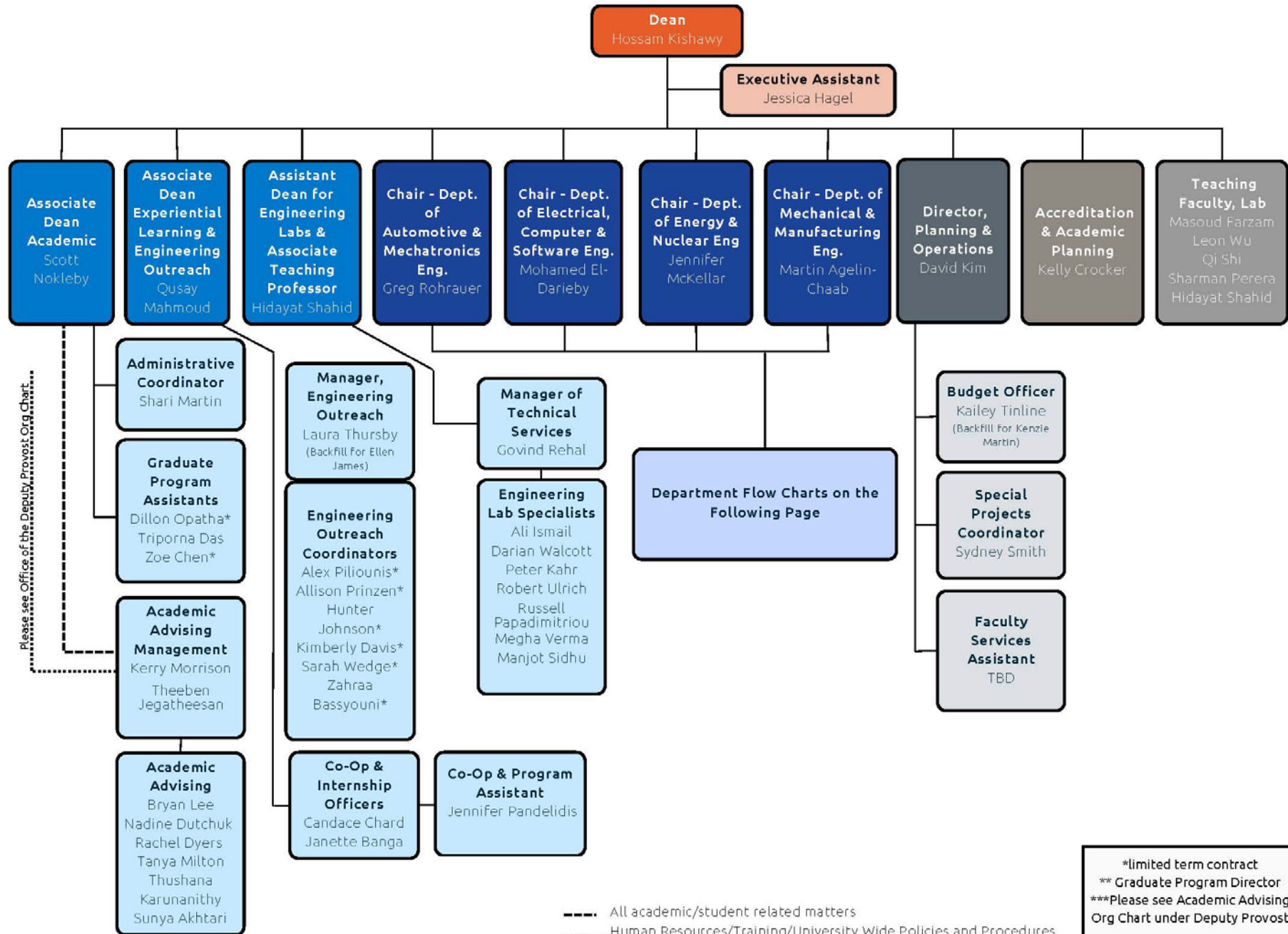

*limited term contract
 ** Graduate Program Director
 ***Please see Academic Advising Org Chart under Deputy Provost

----- All academic/student related matters
 Human Resources/Training/University Wide Policies and Procedures

Faculty of Engineering & Applied Science

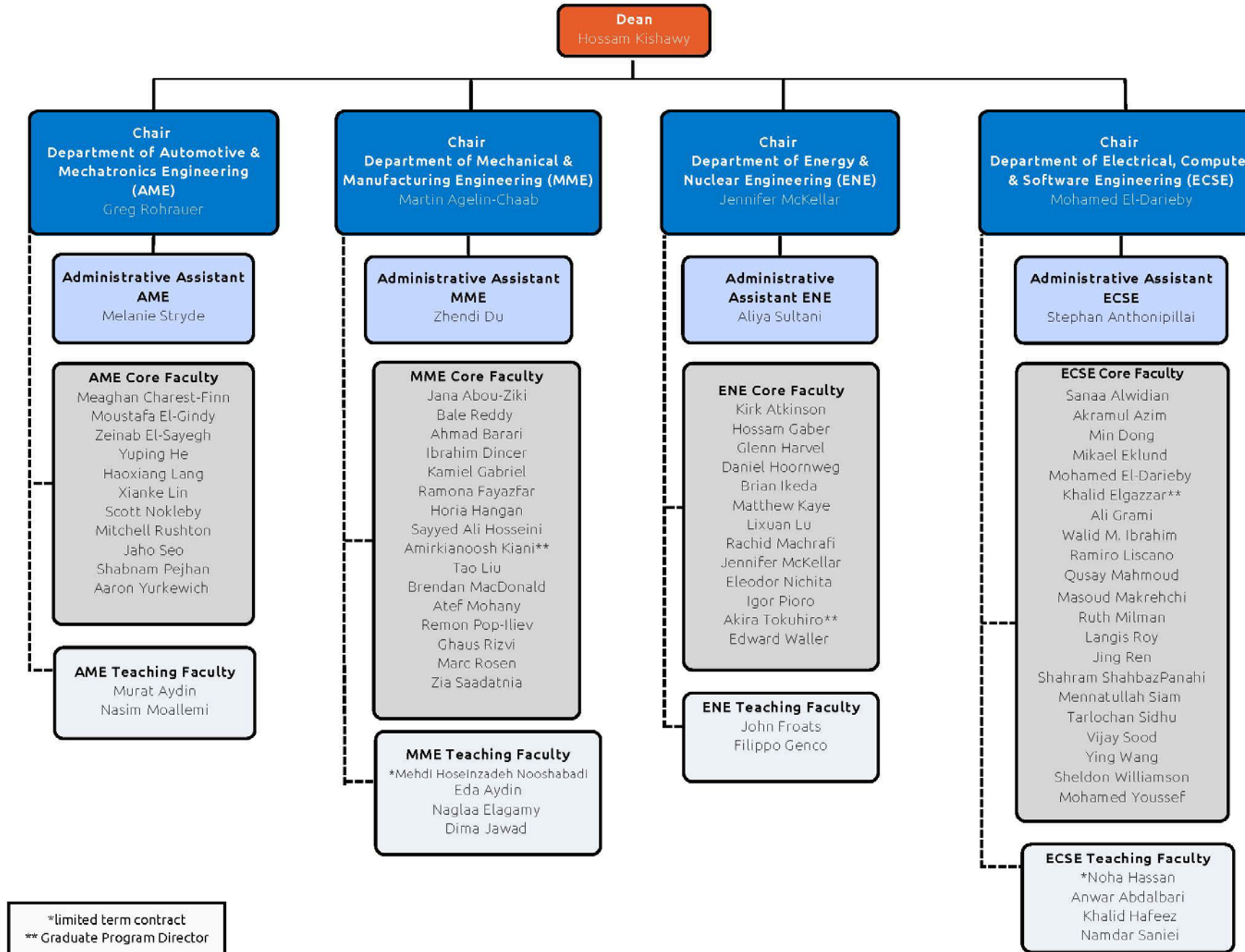

Faculty of Health Sciences- Faculty Council

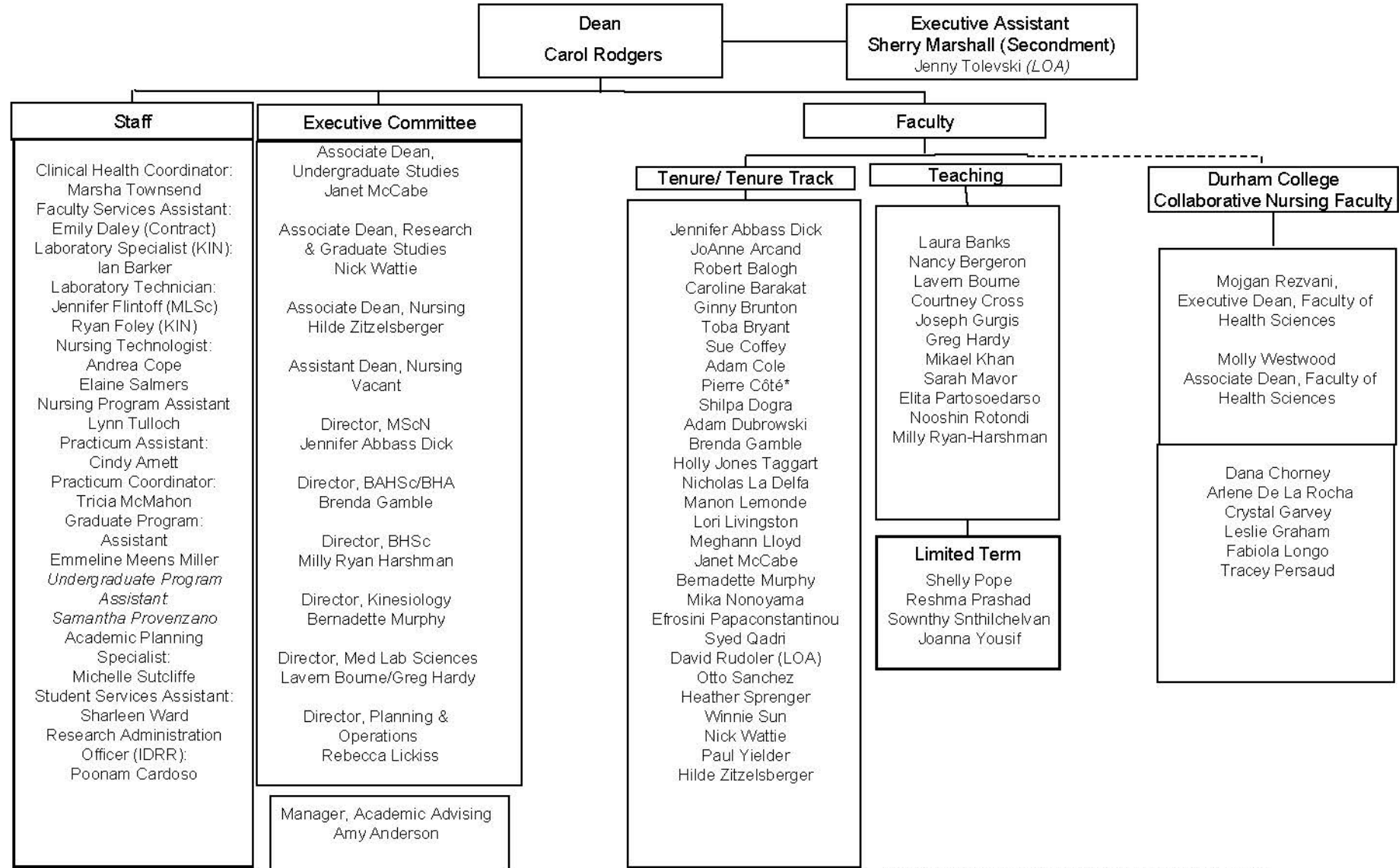

* Director: Institute for Disability and Rehabilitation Research

Faculty of Health Sciences – continued

Institute for Disability and Rehabilitation Research at Ontario Tech University-CMCC

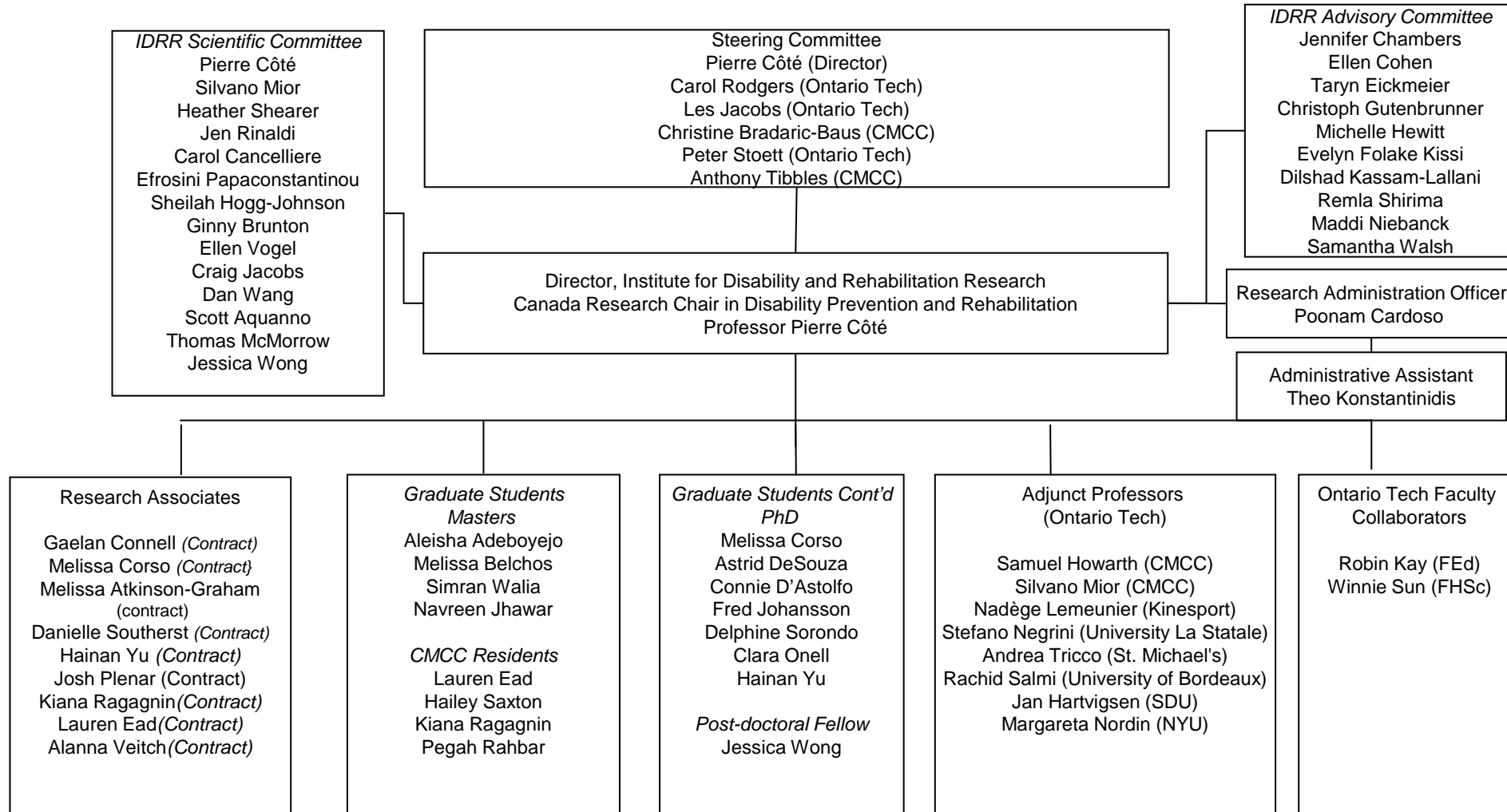

Faculty of Health Sciences – continued

Institute for Disability and Rehabilitation Research at Ontario Tech University-CMCC

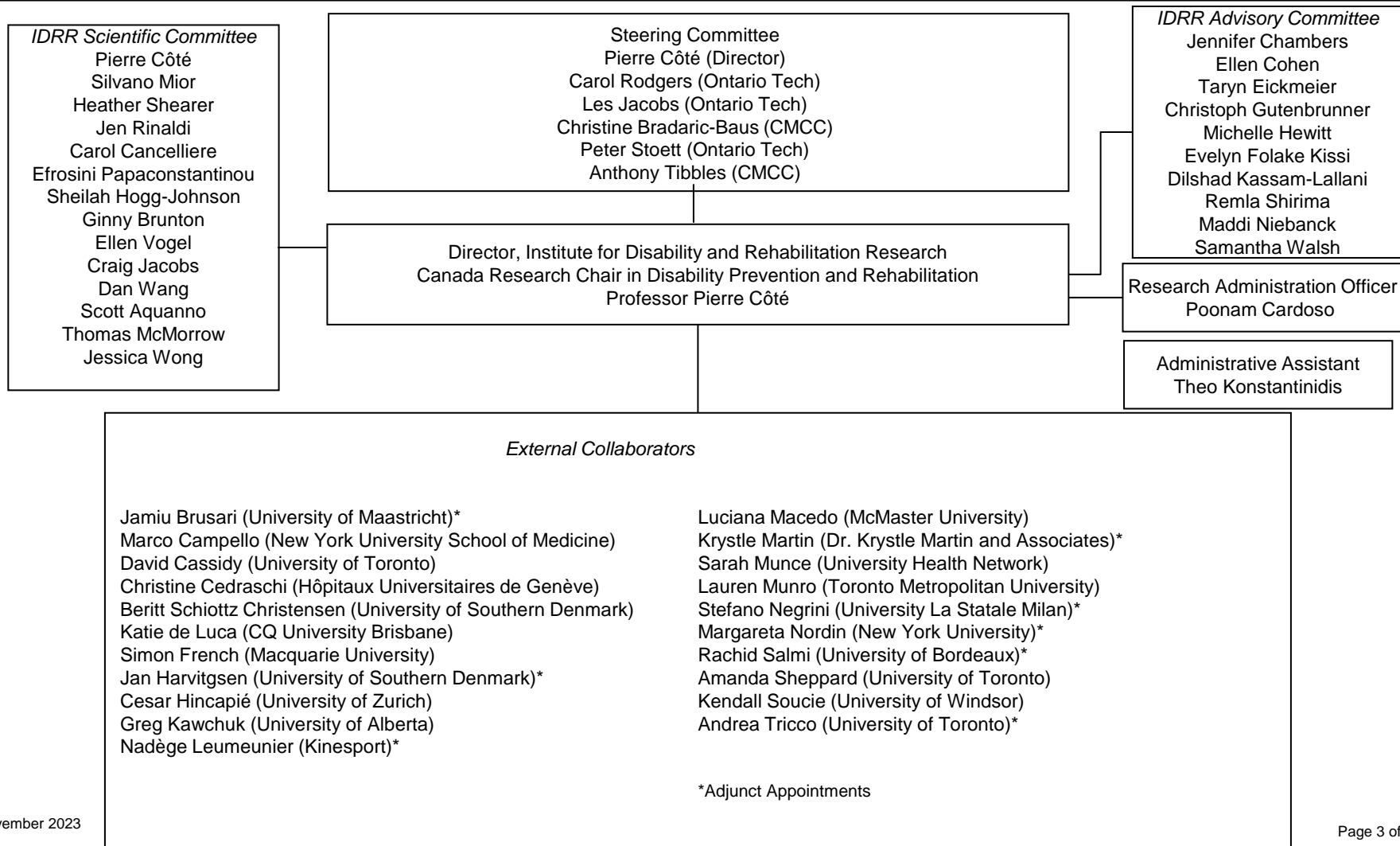

Faculty of Science

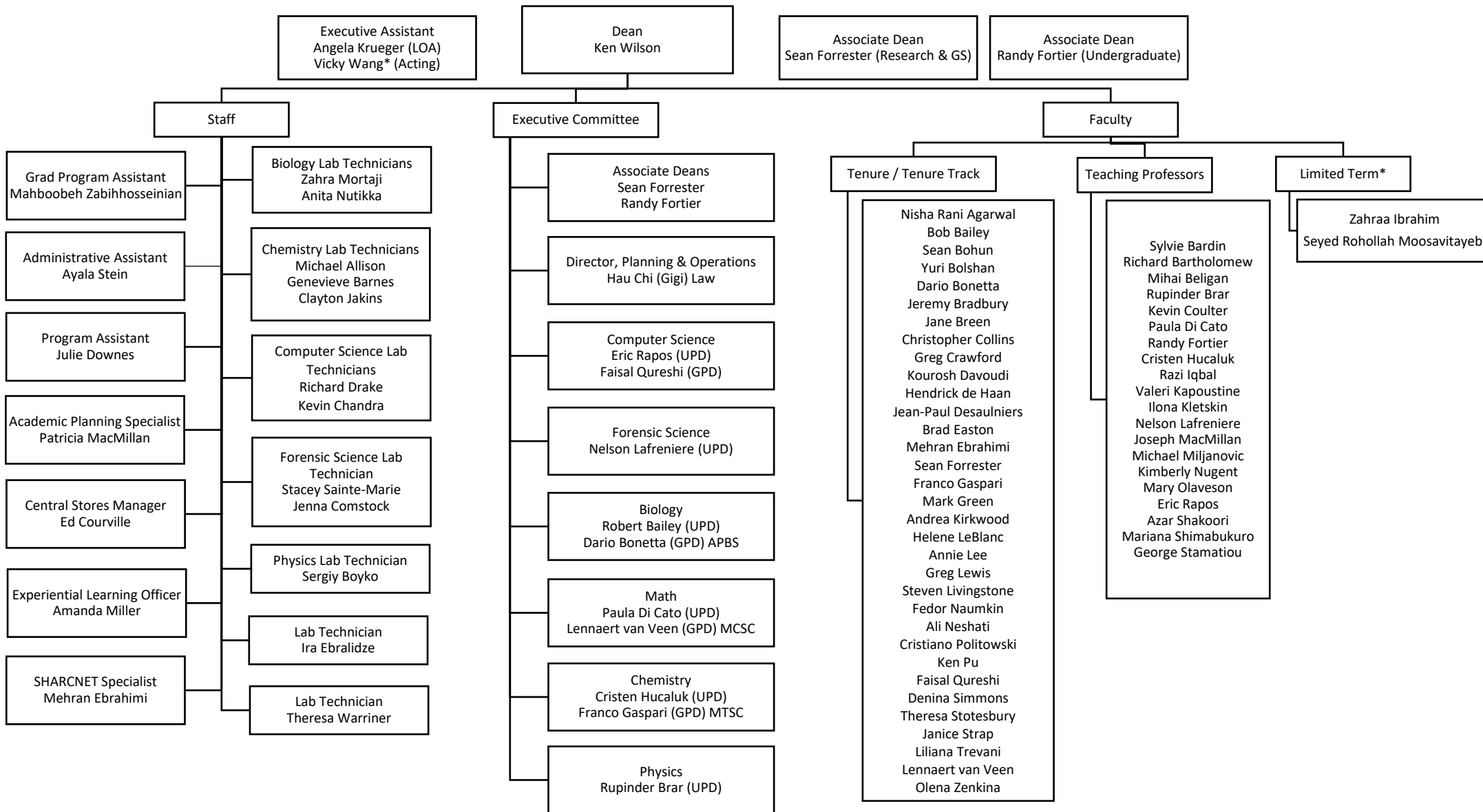

Faculty of Social Science and Humanities

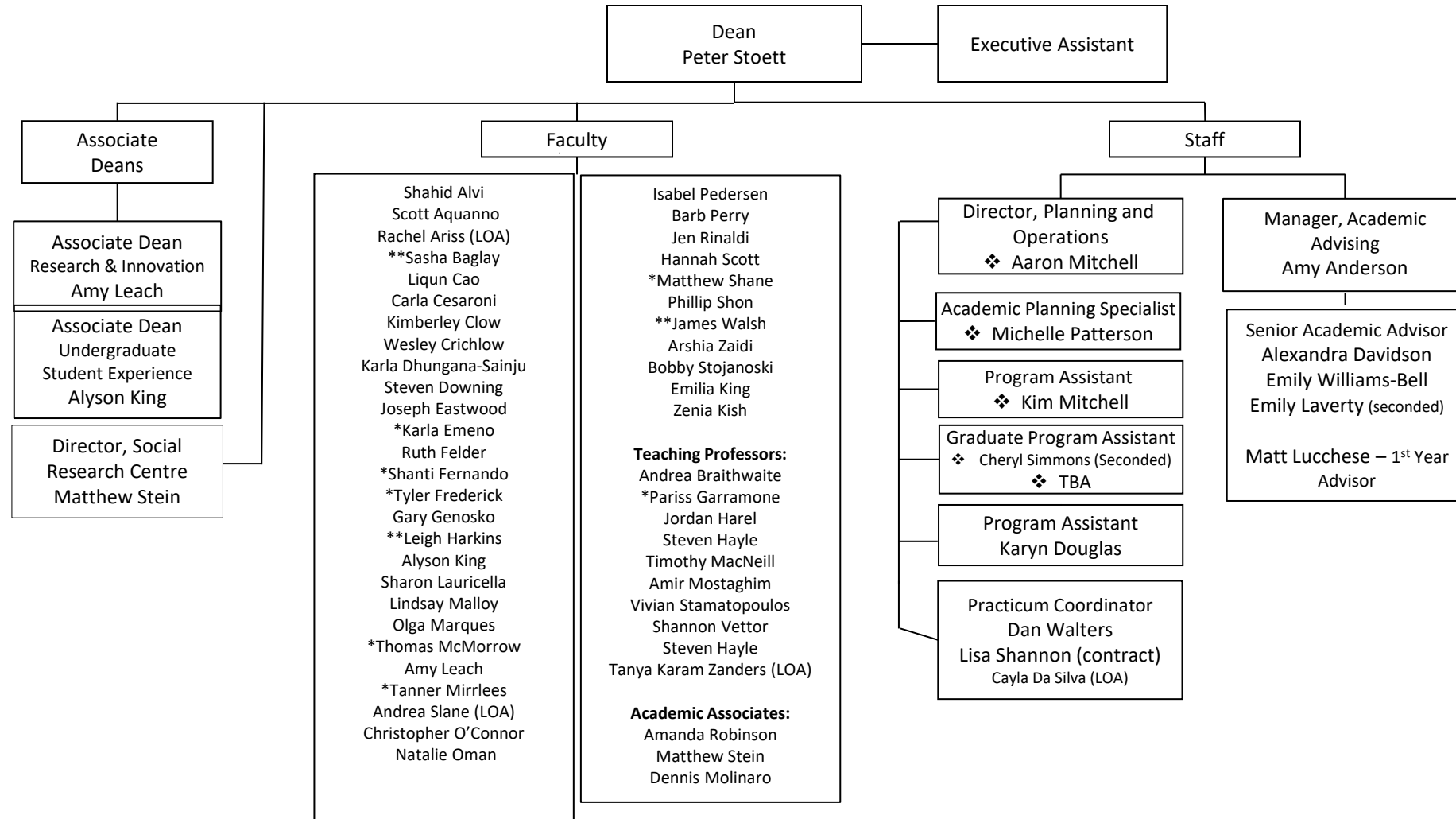

Advancement Office and Alumni Relations

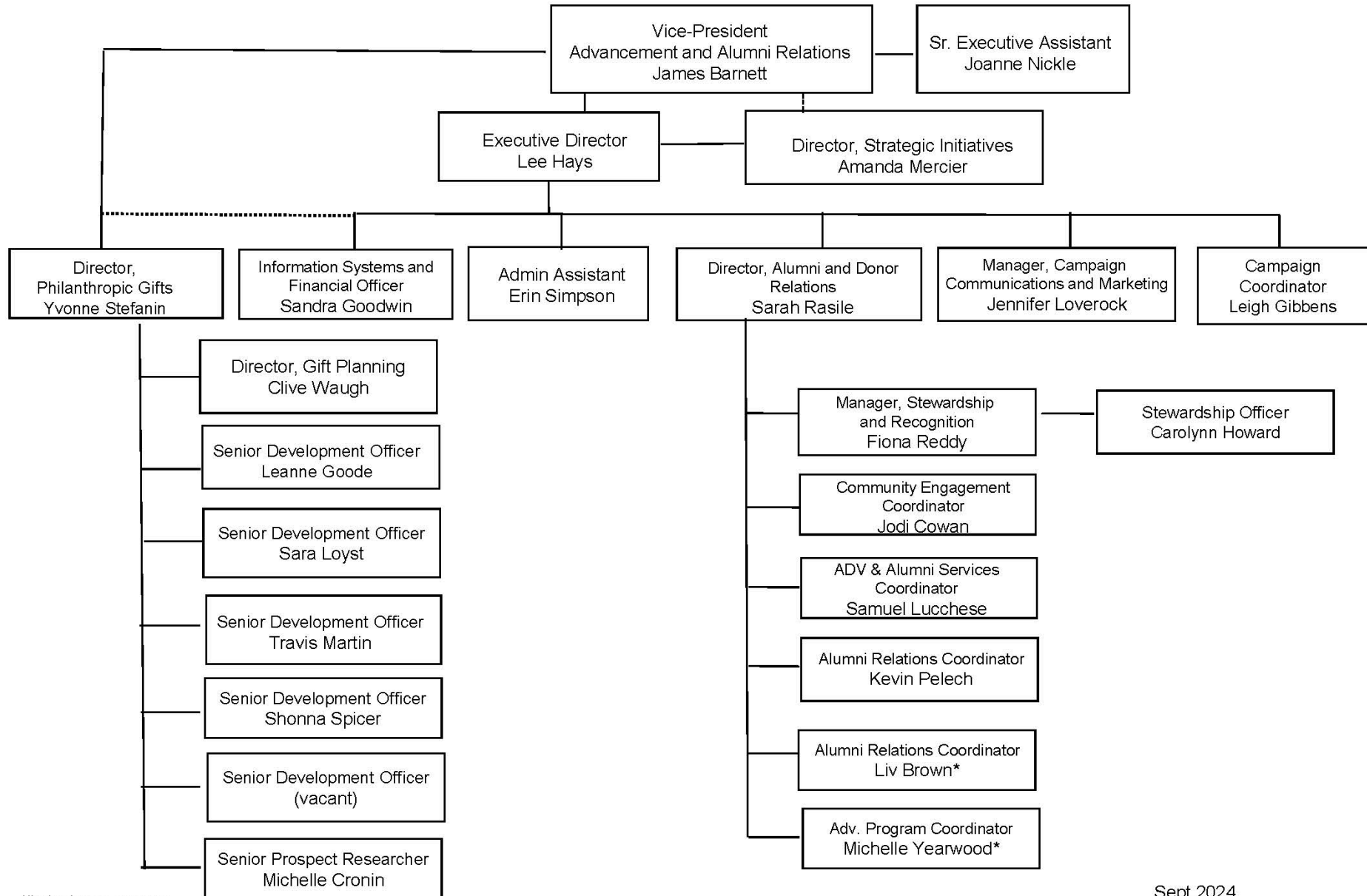

*limited term contract

Automotive Centre of Excellence (ACE)

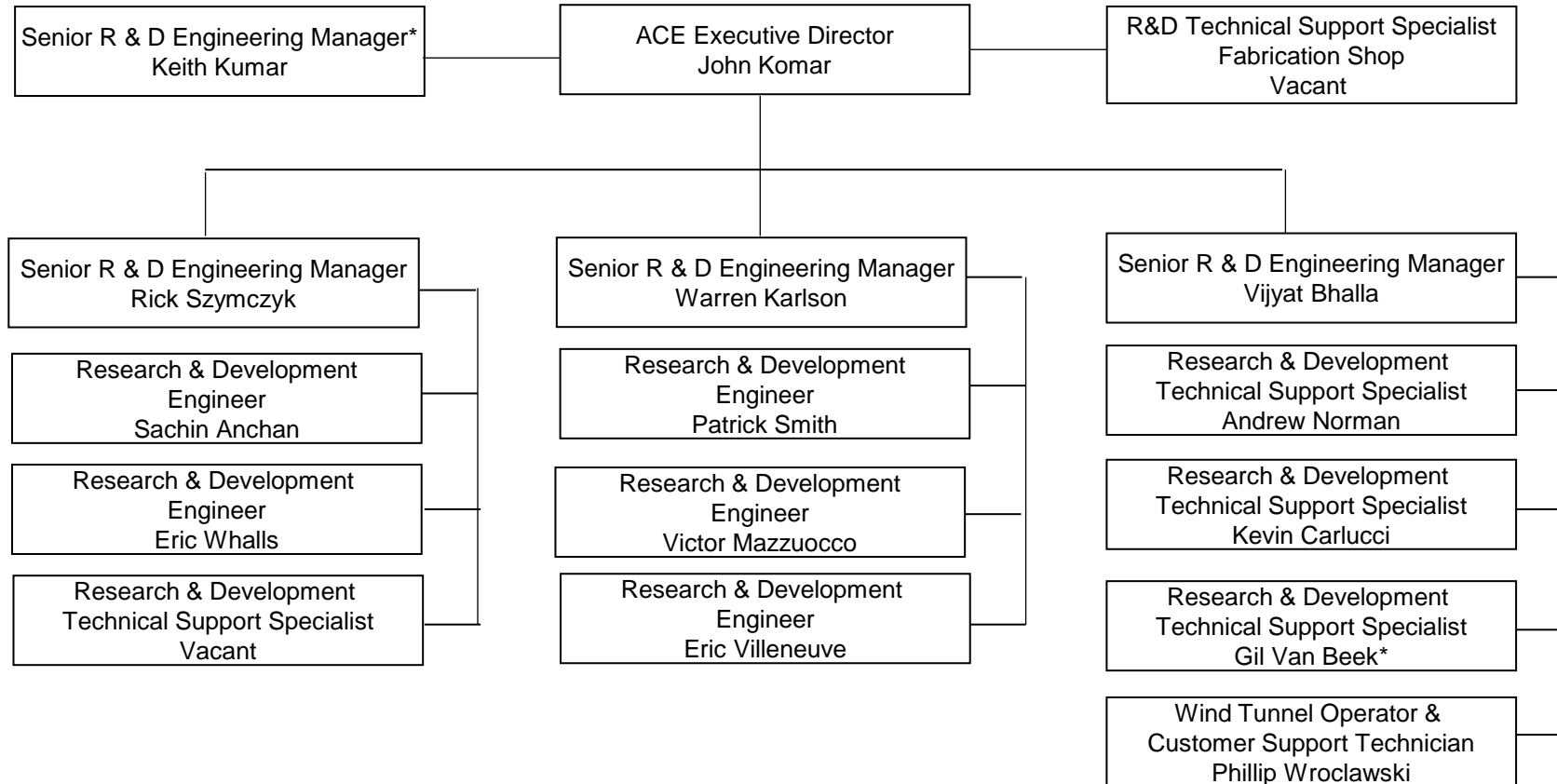

Automotive Centre of Excellence (ACE)

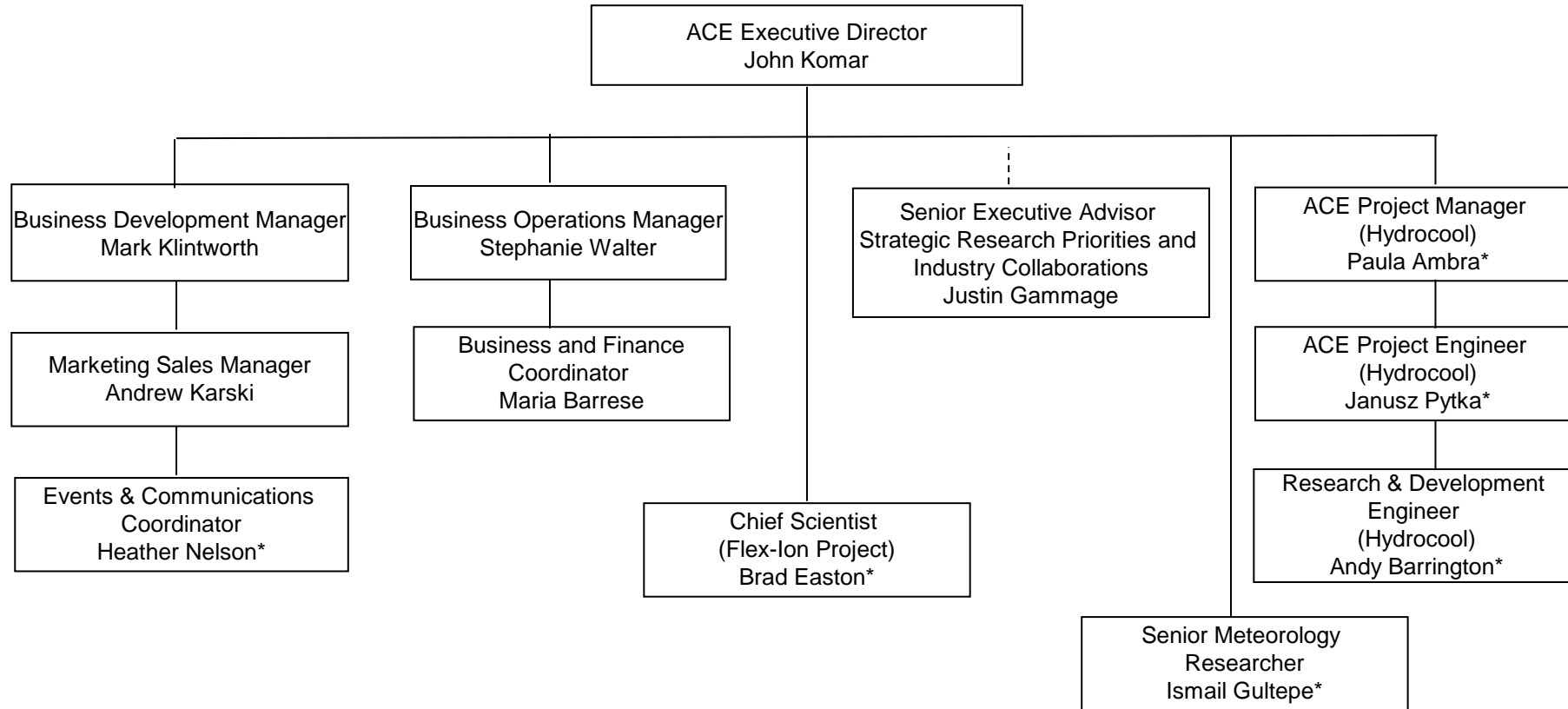

*limited term contract

FINANCE

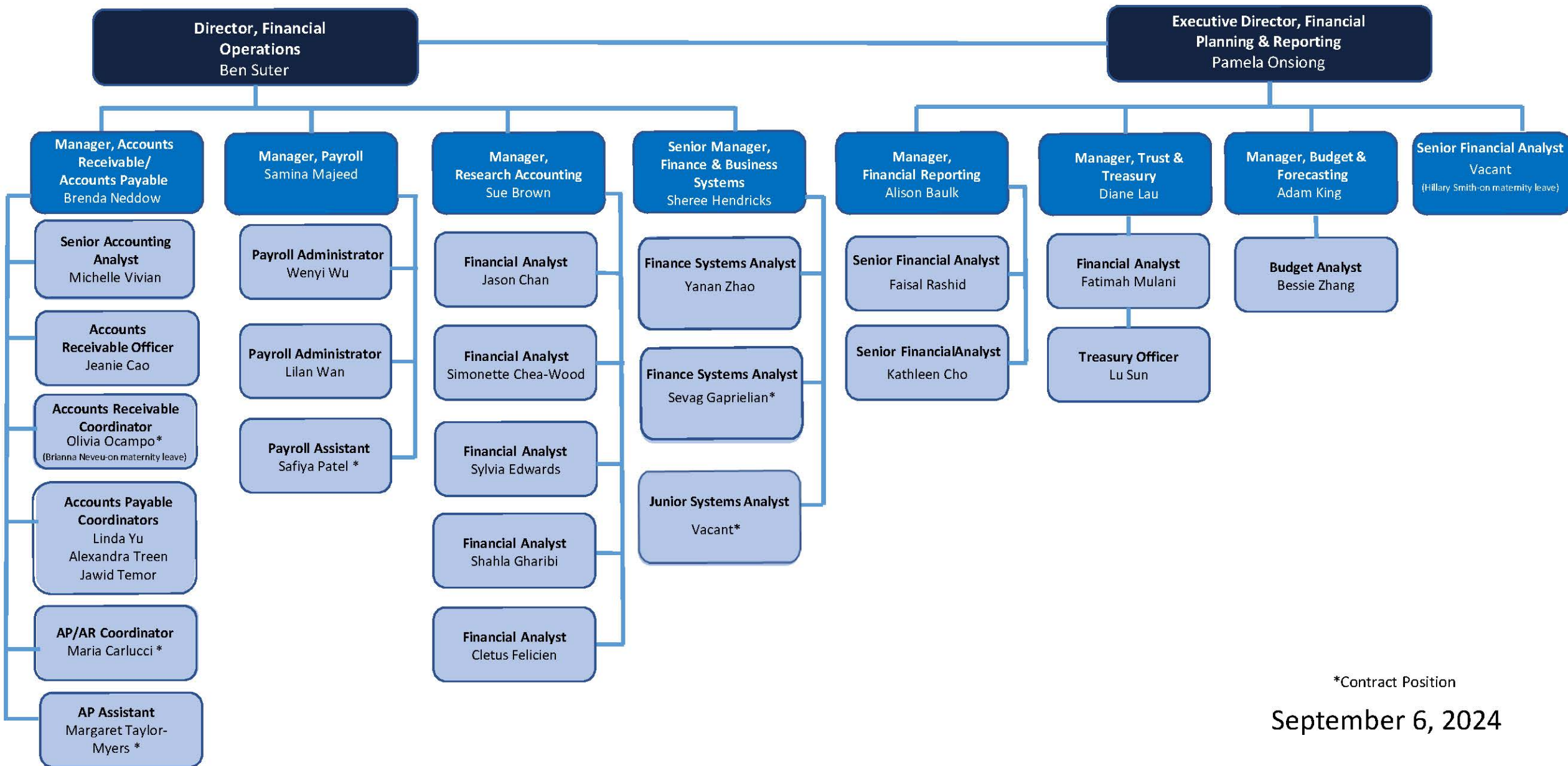

*Contract Position

September 6, 2024

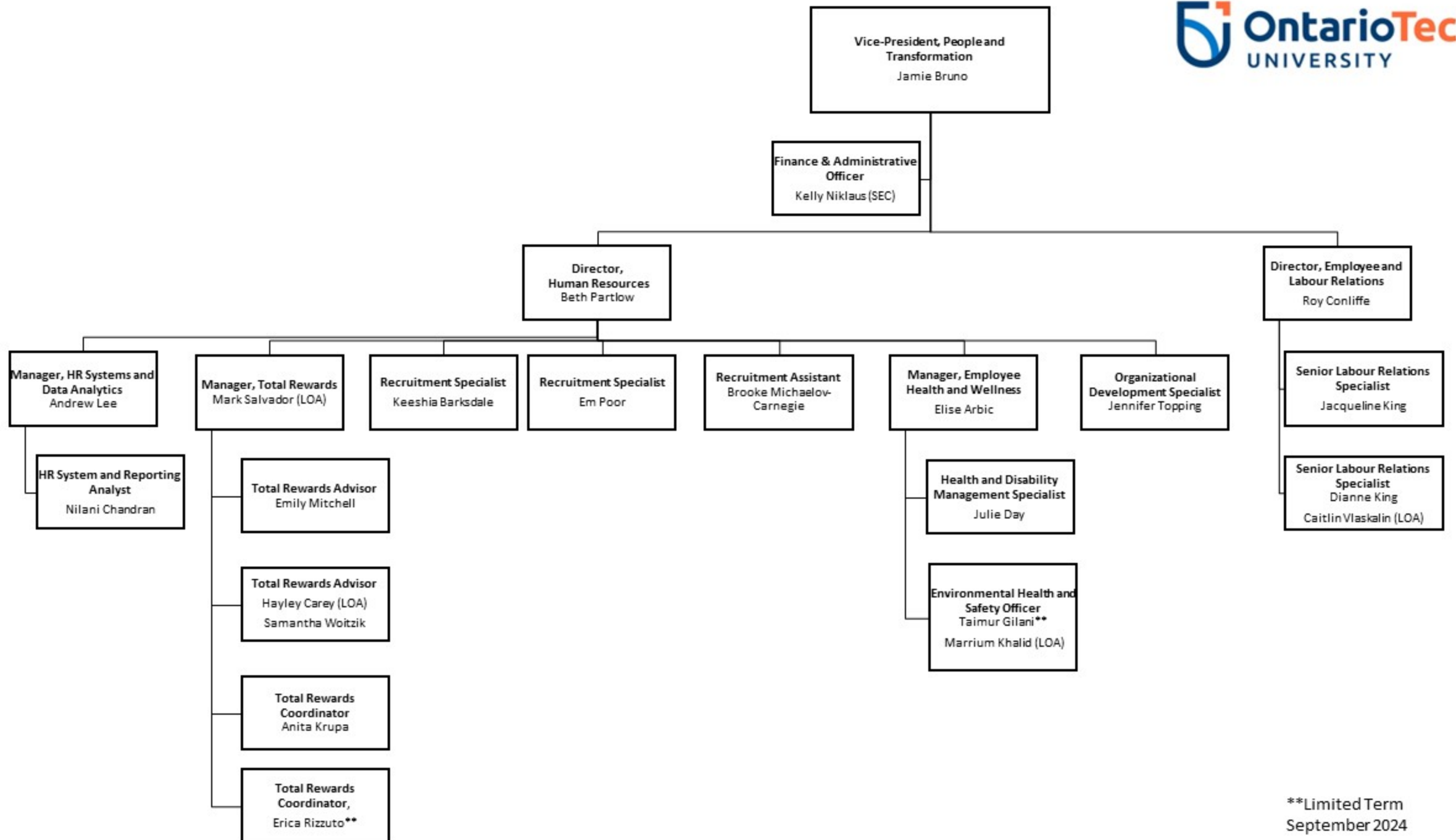

**Limited Term
September 2024

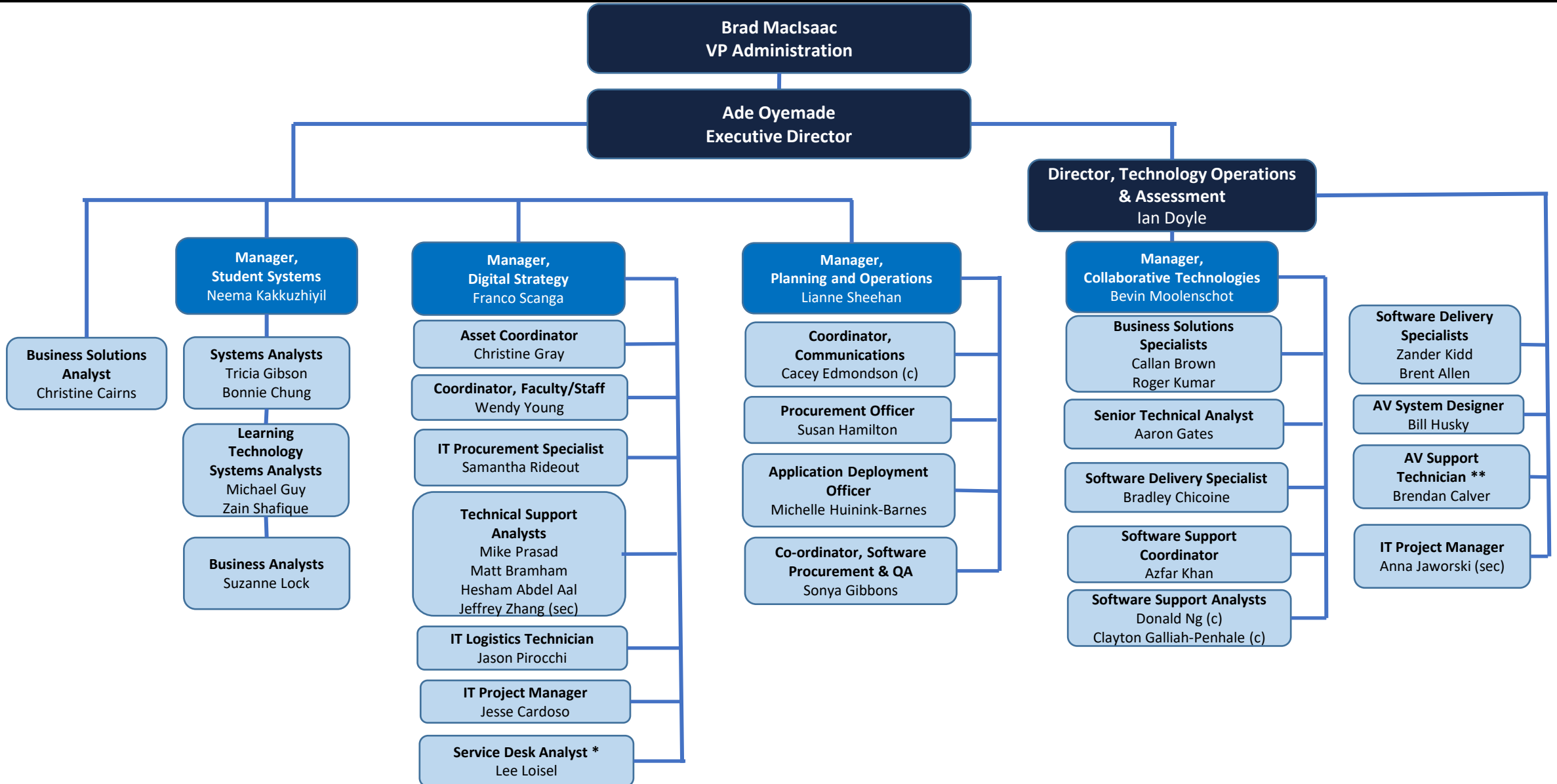

* Also reports to Manager, Client Services & IT Support – Durham College

** Also reports to Manager, AV Services – Durham College

Library

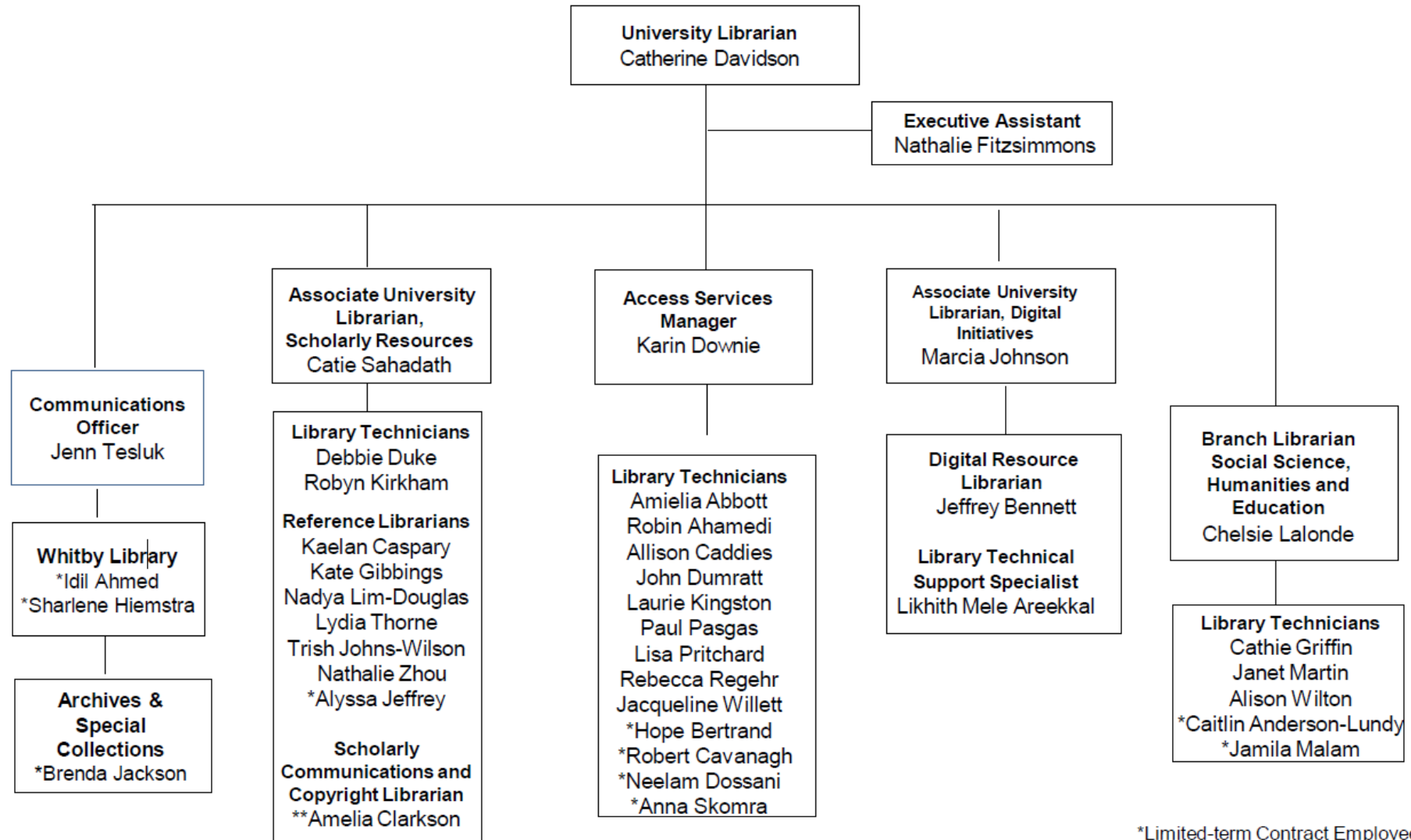

Office of Campus Infrastructure and Sustainability



Office of Planning and Analysis

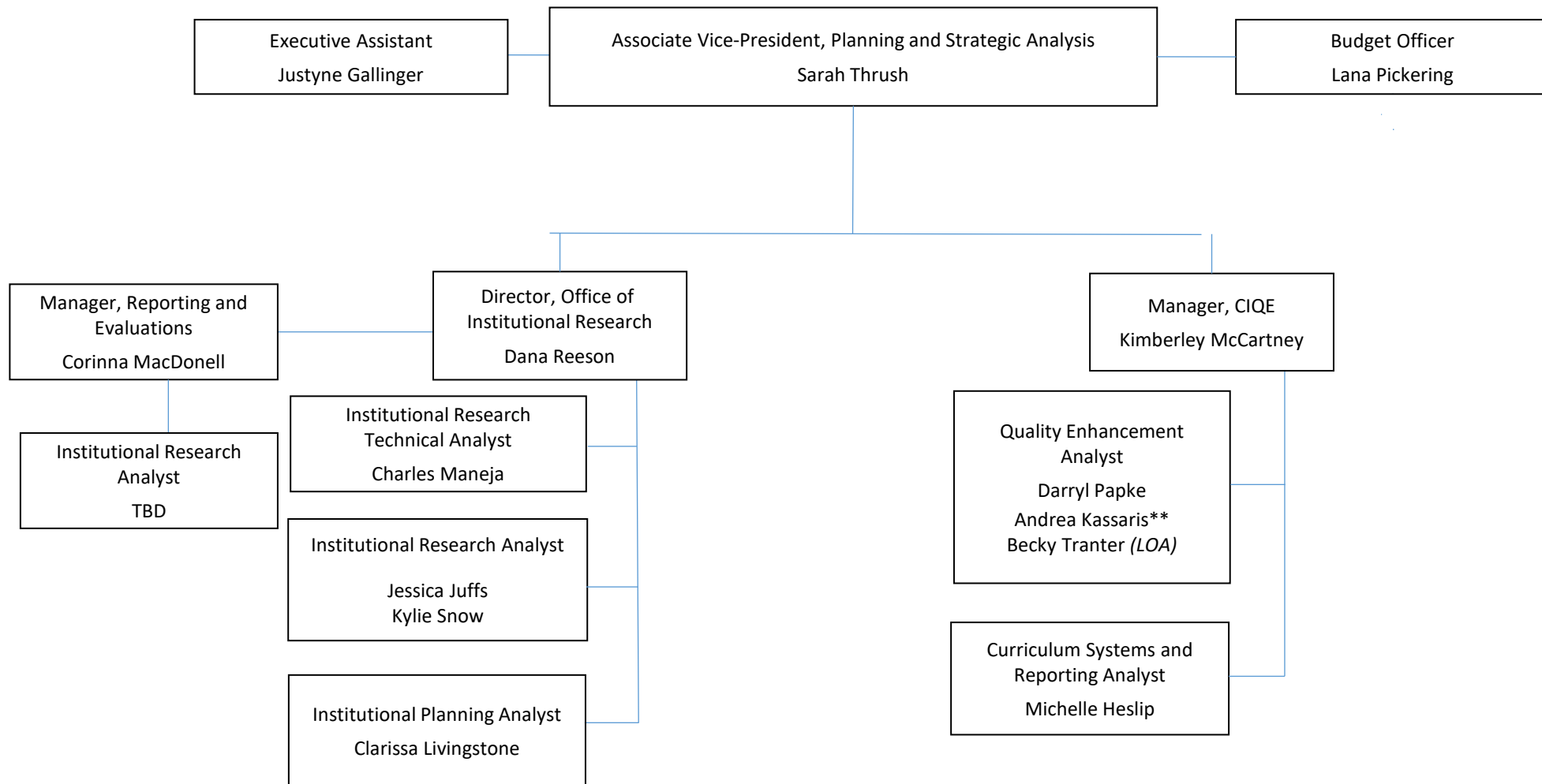

Office of the Deputy Provost

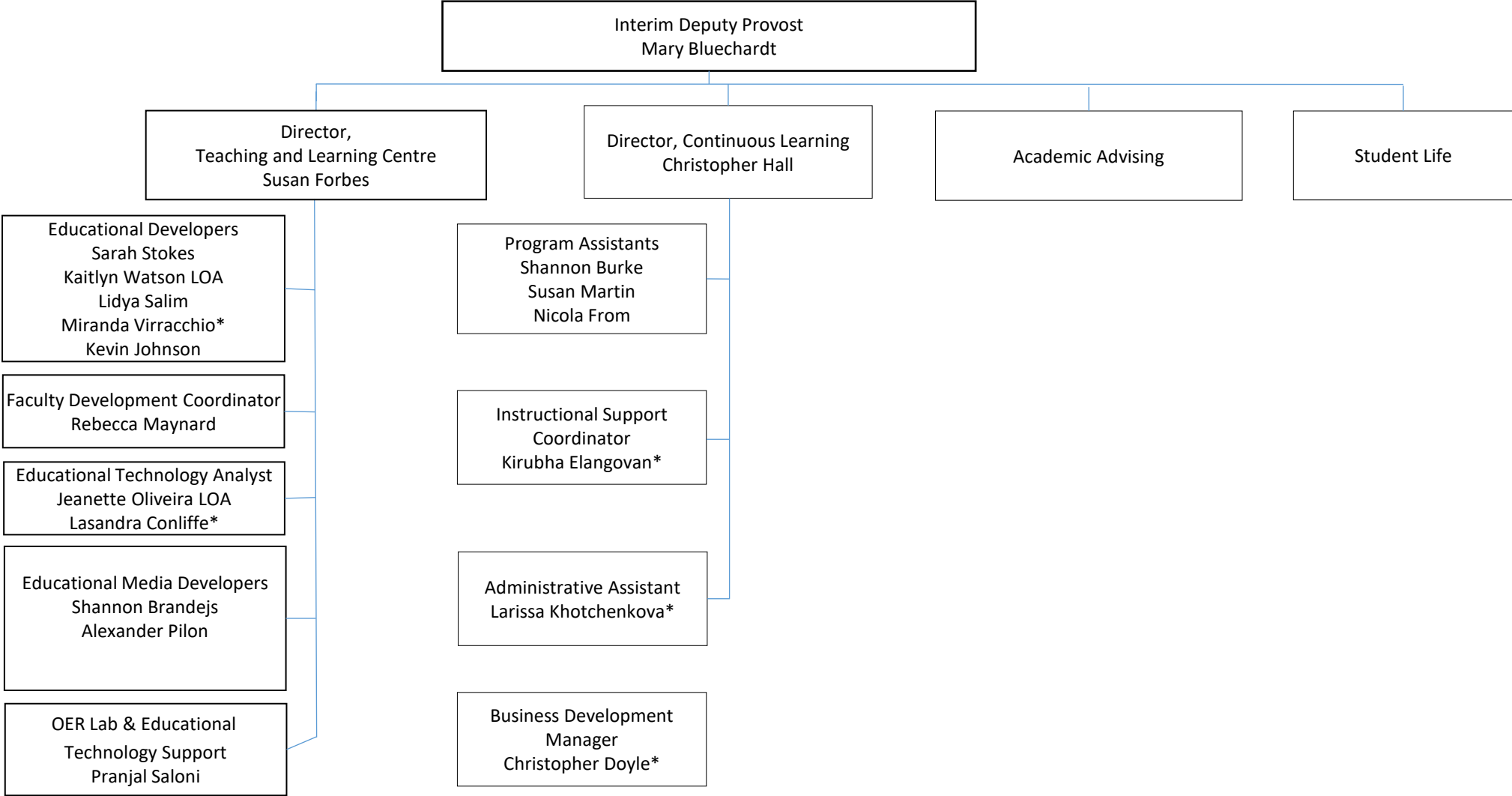

*limited term contract

Academic Advising

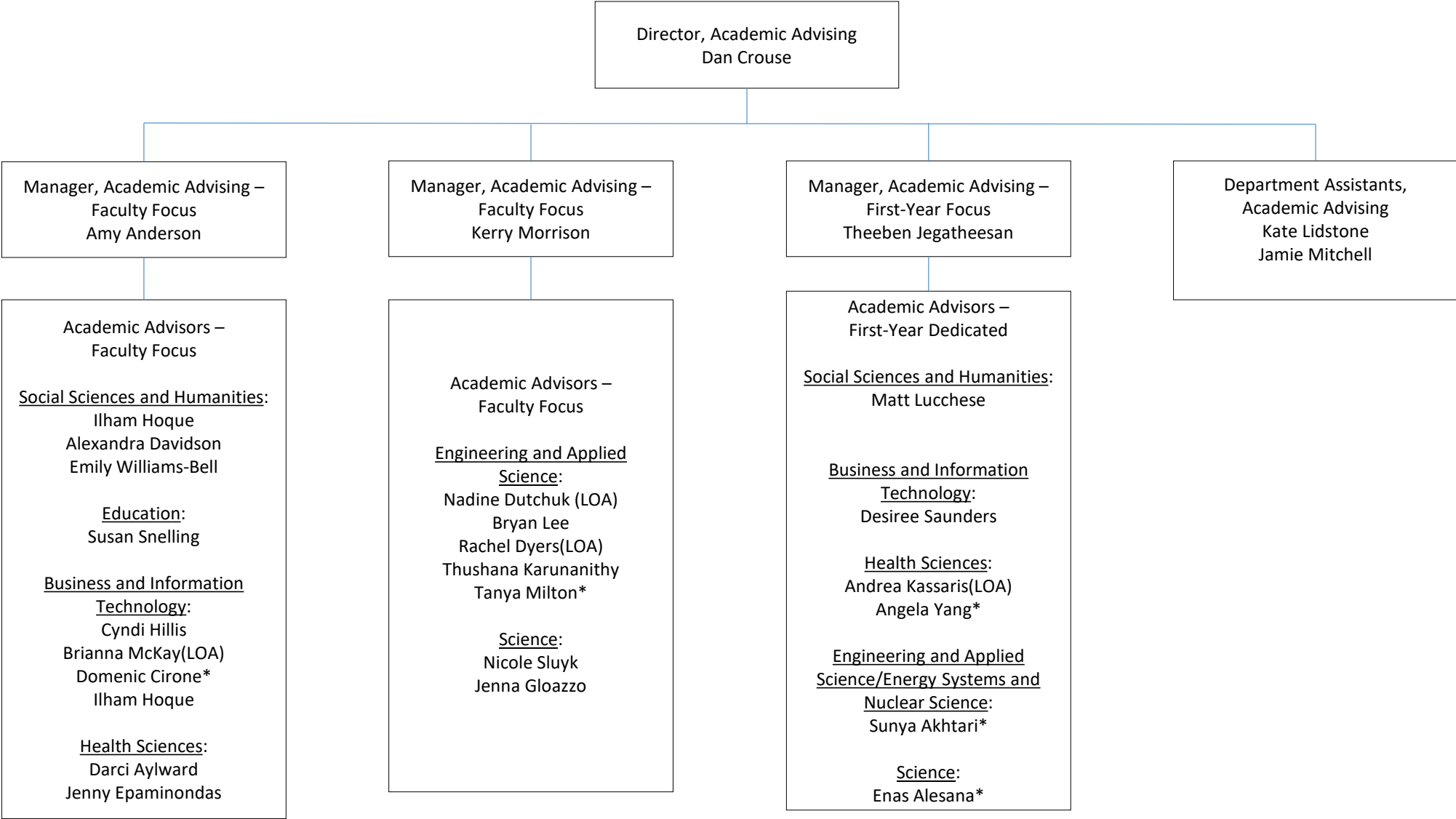

*limited term contract

Office of Student Life

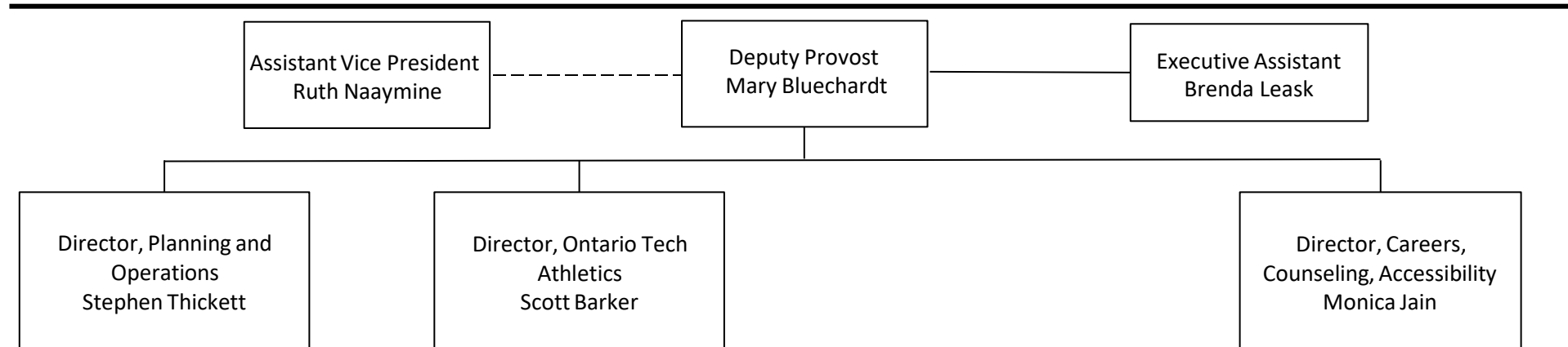

Office of Student Life Planning and Operations

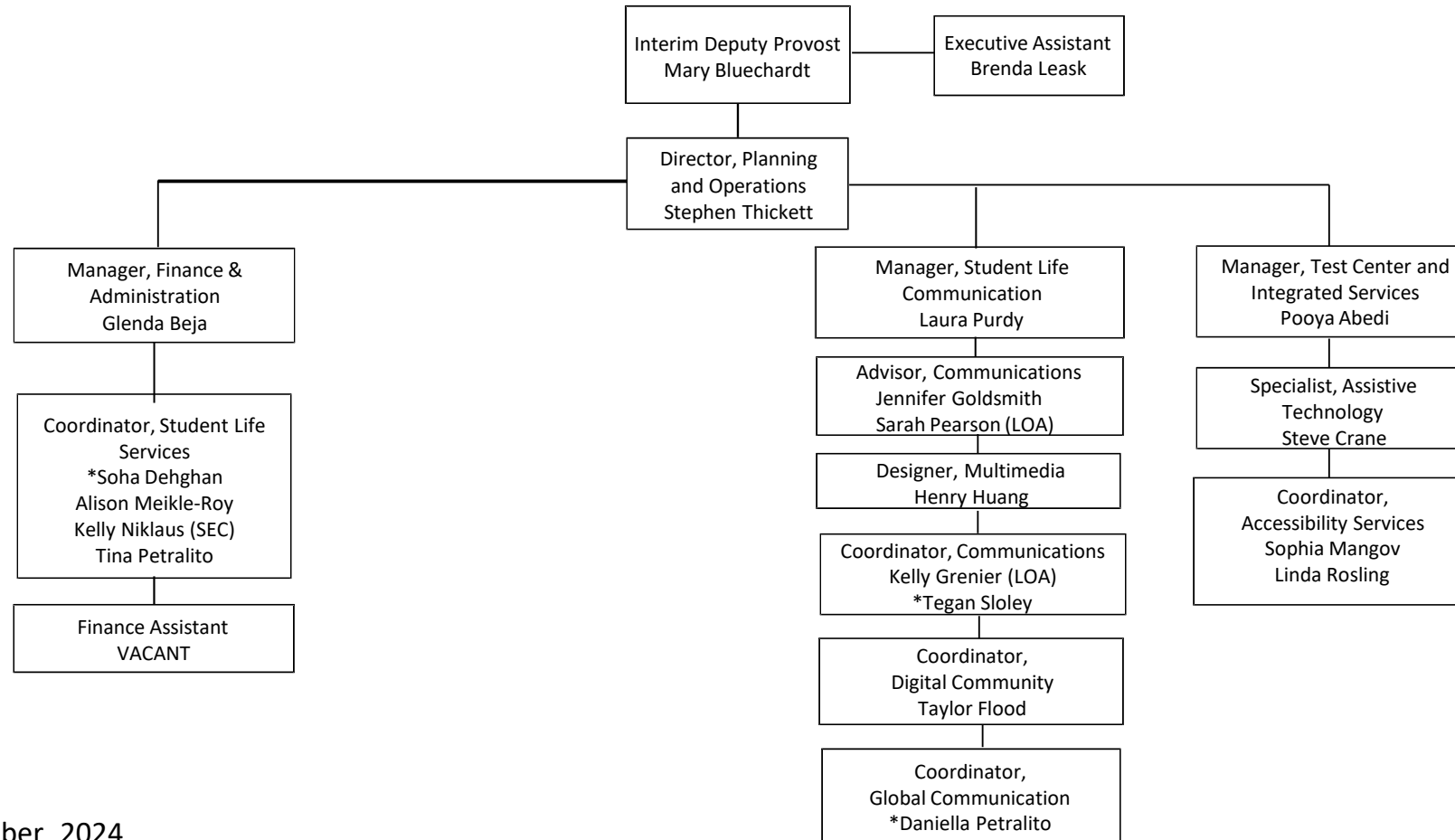

September 2024

*Contract position

Office of Student Life Athletics and Recreation

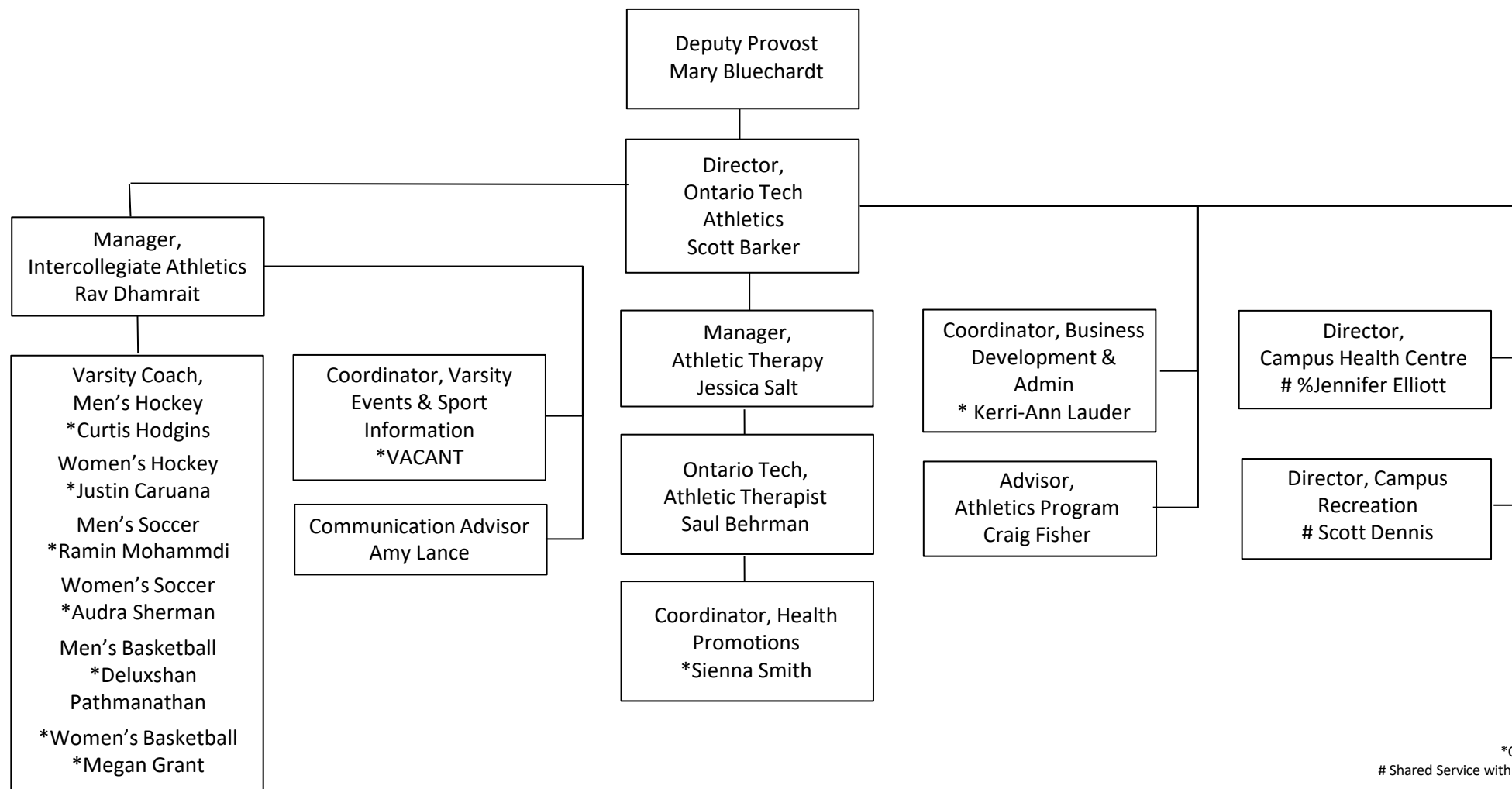

*Contract position
Shared Service with Durham College
% Dual Report

Office of Student Life Careers, Counselling and Accessibility

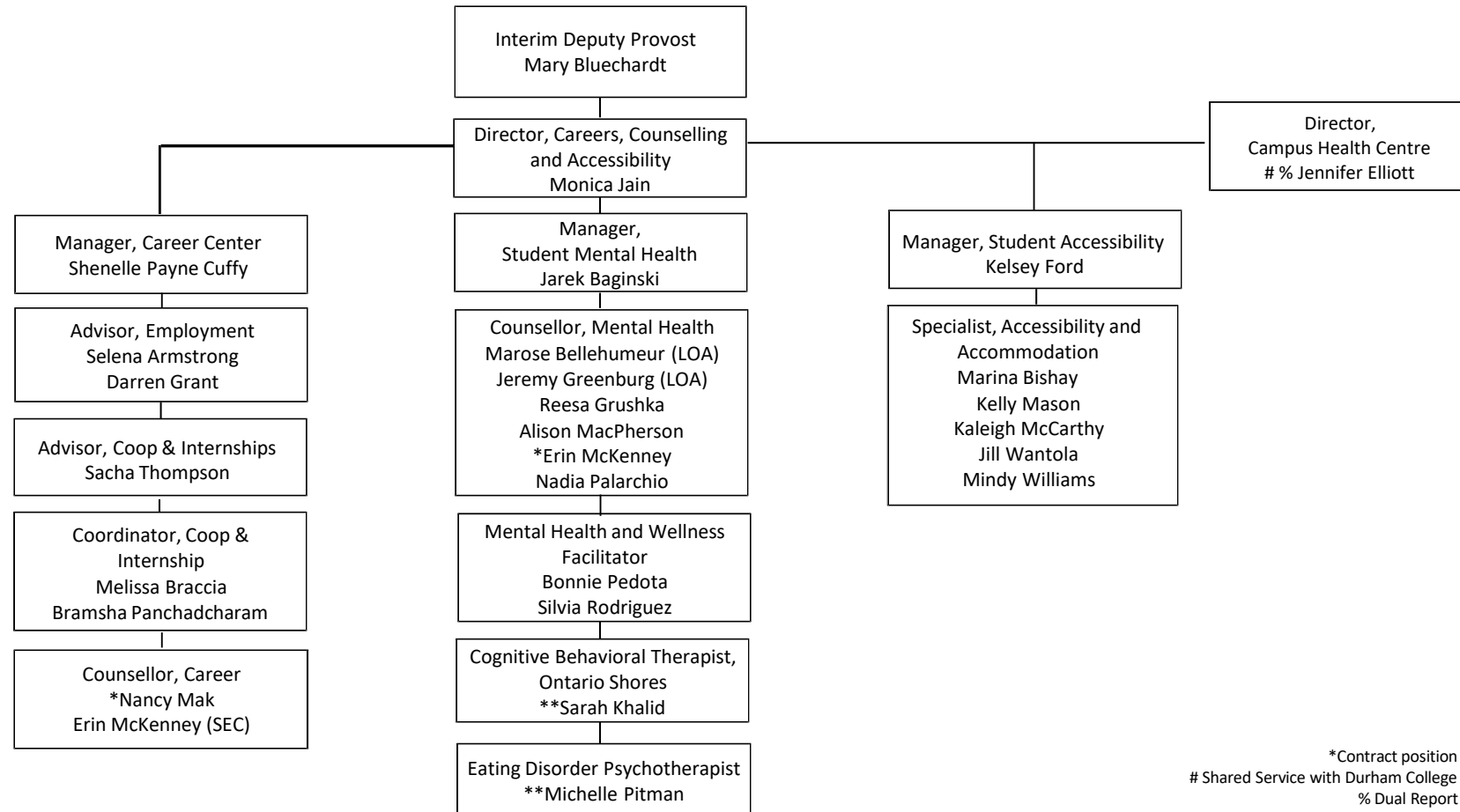

*Contract position
Shared Service with Durham College
% Dual Report

Office of Student Life Student Success

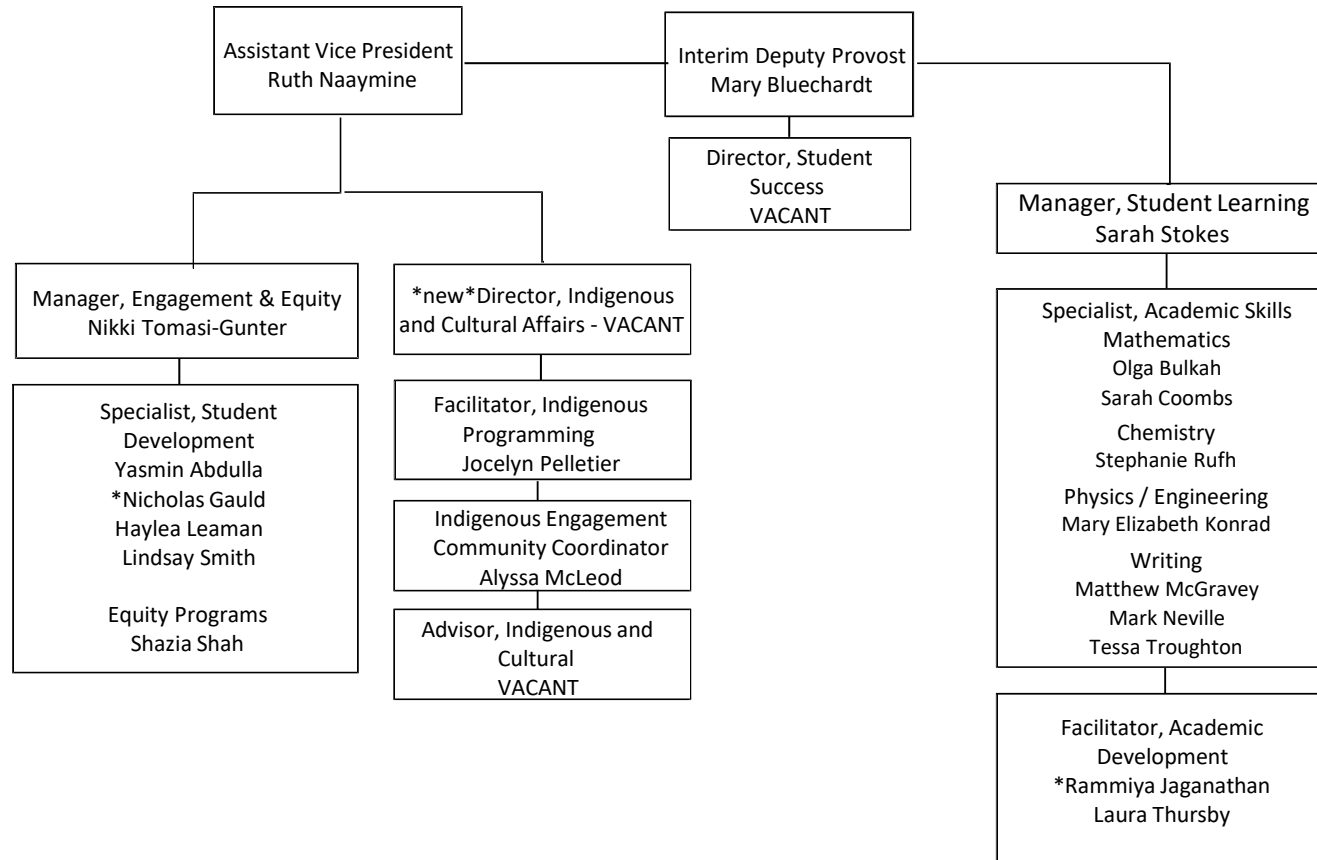

Office of the President and Vice-Chancellor & Board of Governors

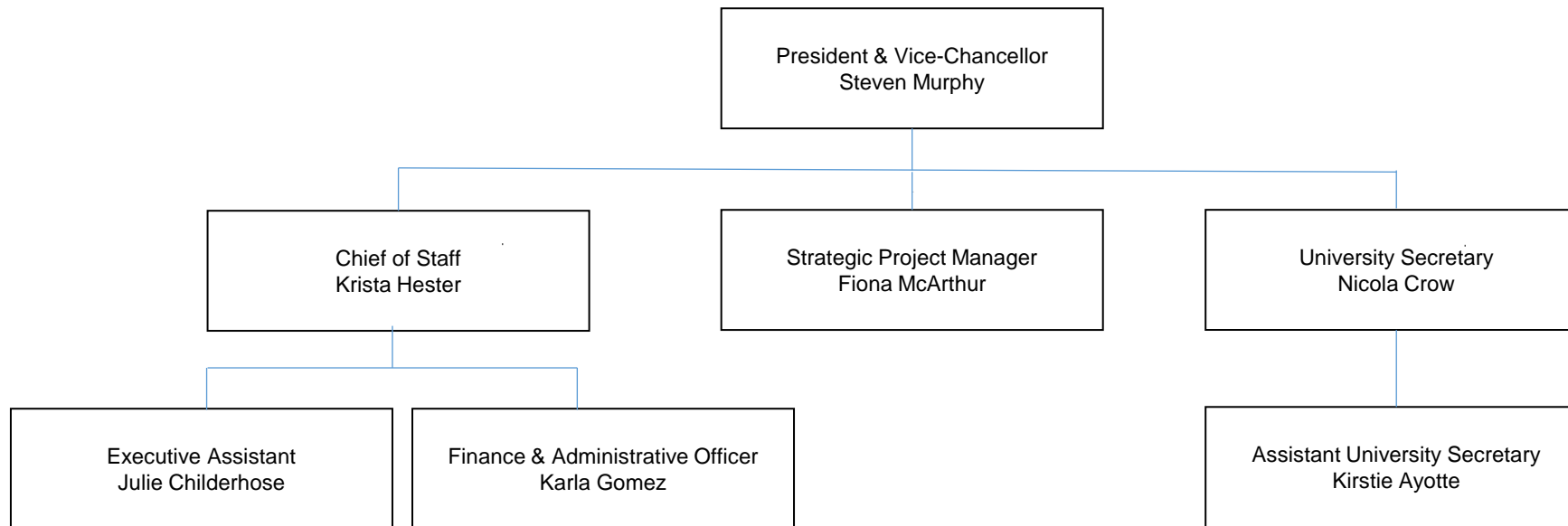

President's Direct Reports

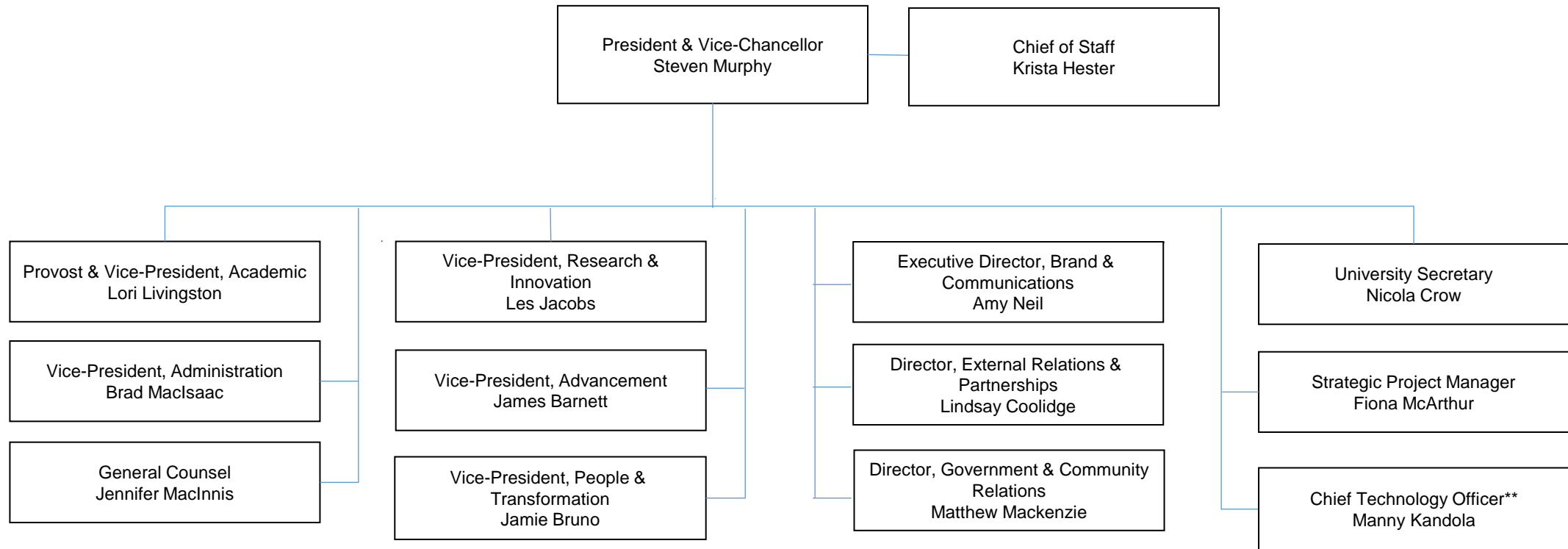

September 2024

Partnership Office and Government Relations

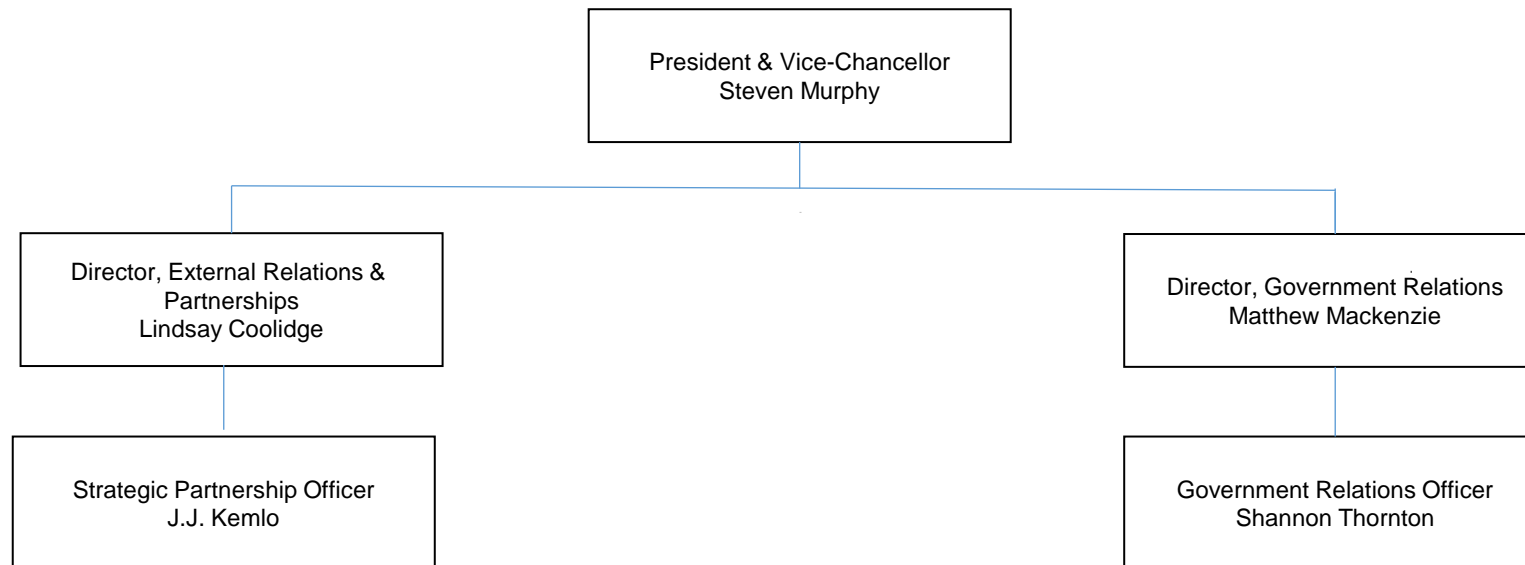

Brand and Communications

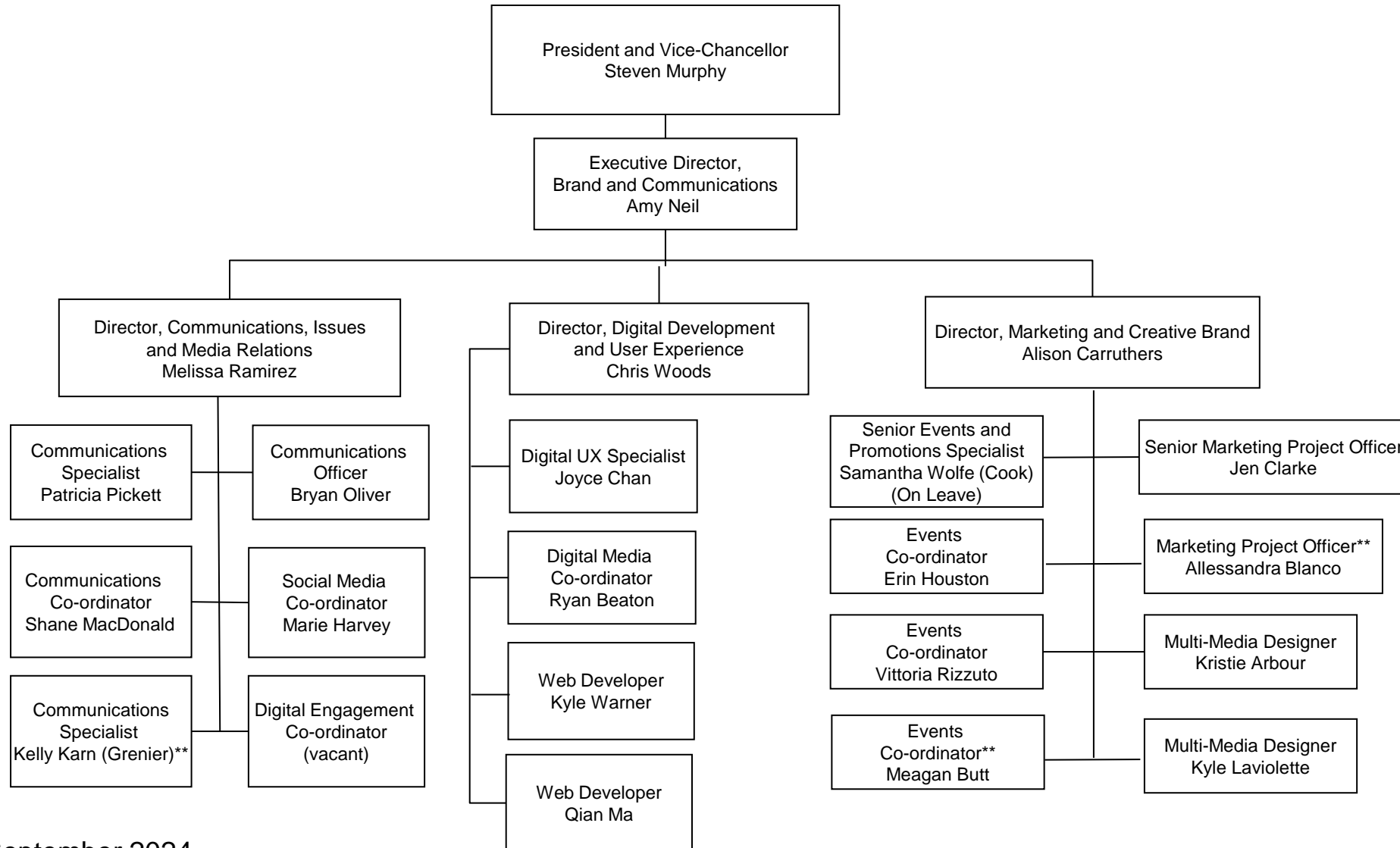

September 2024

** Limited Term Appointment

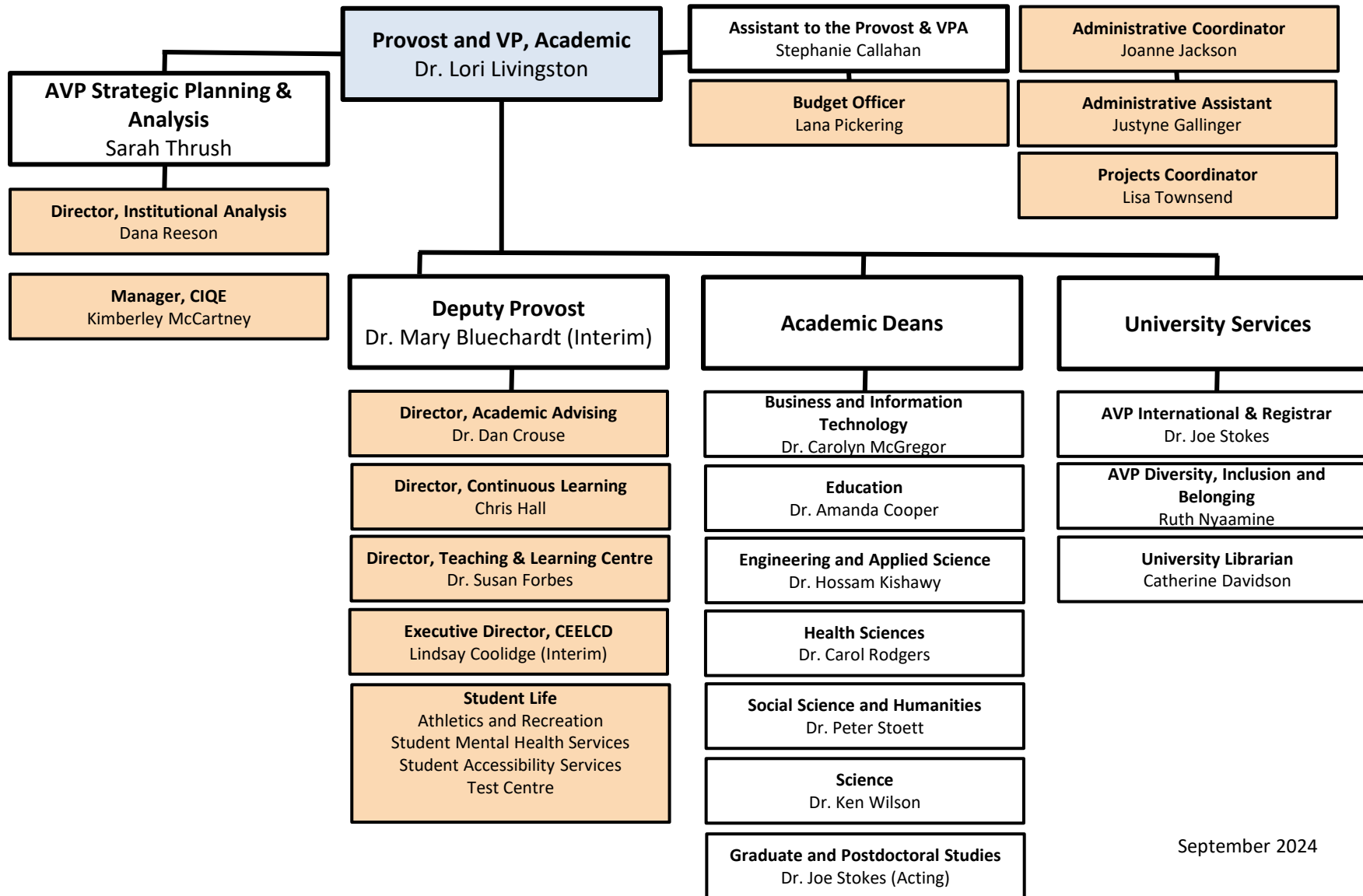

September 2024



Office of the Registrar

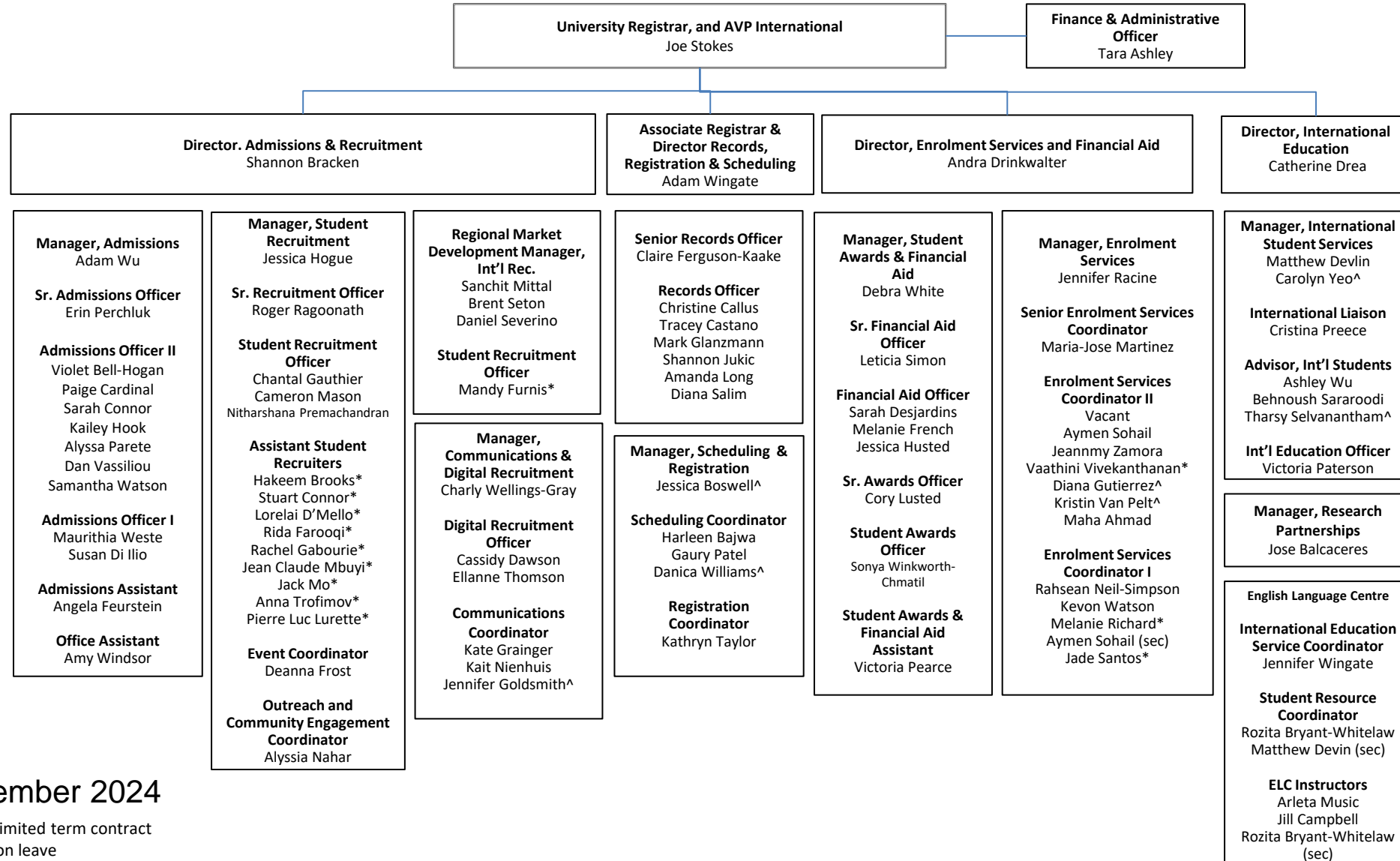

September 2024

*limited term contract

^on leave

VICE PRESIDENT ADMINISTRATION

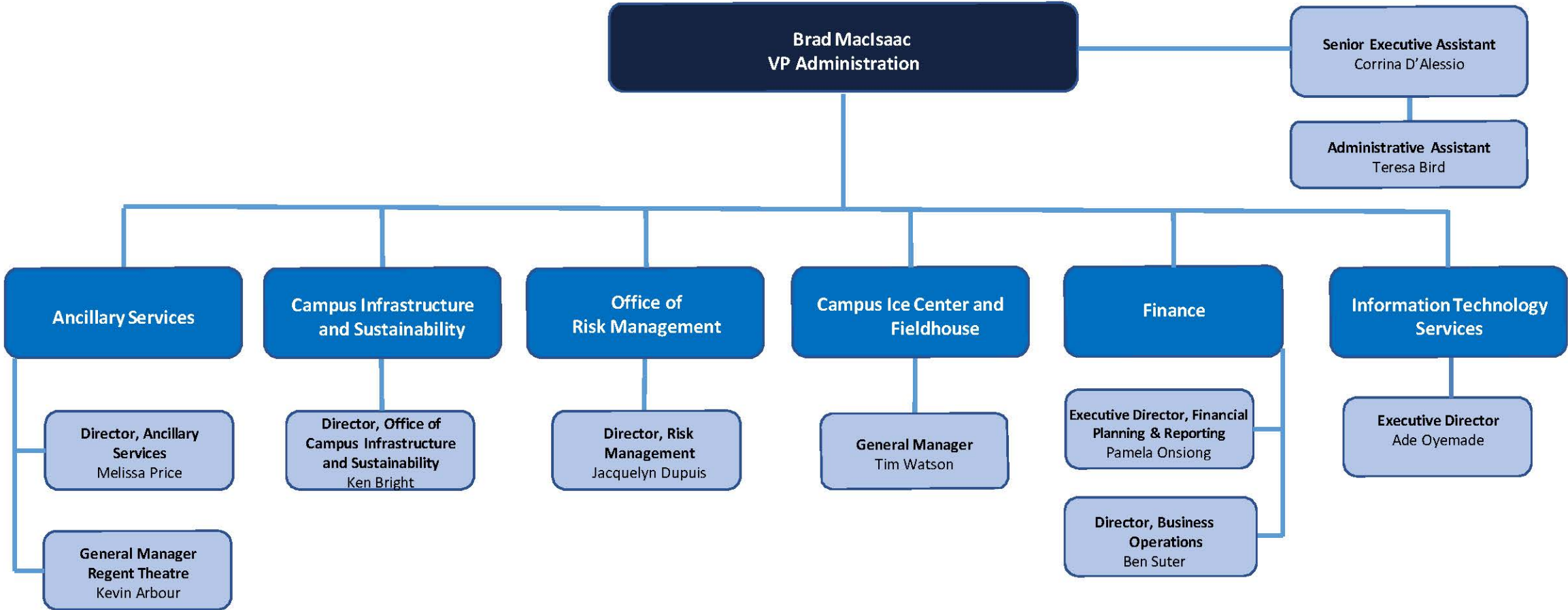

Office of the Vice-President, Research and Innovation

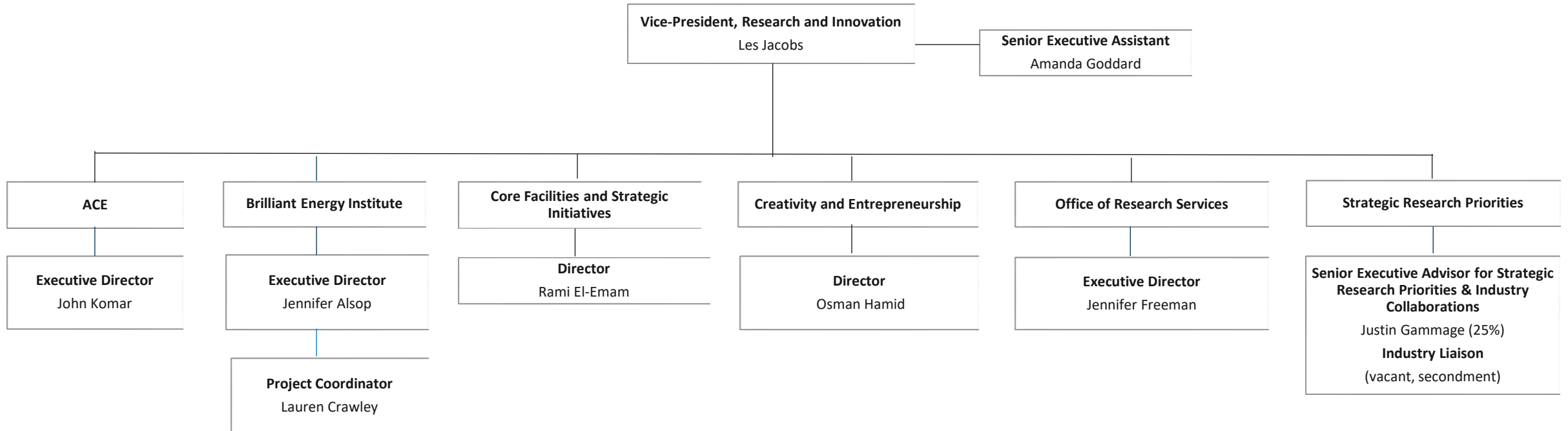

Office of the Vice-President, Research and Innovation

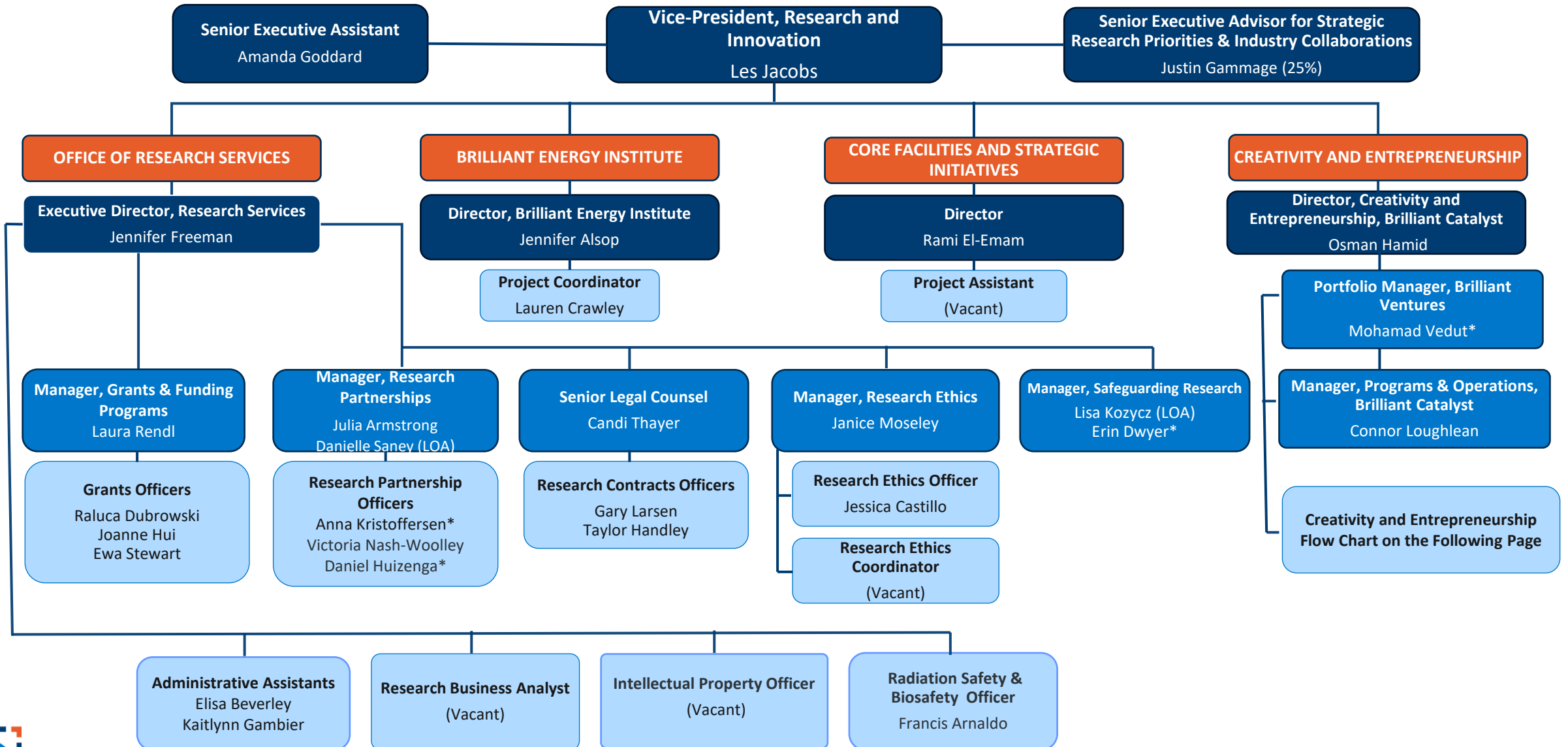

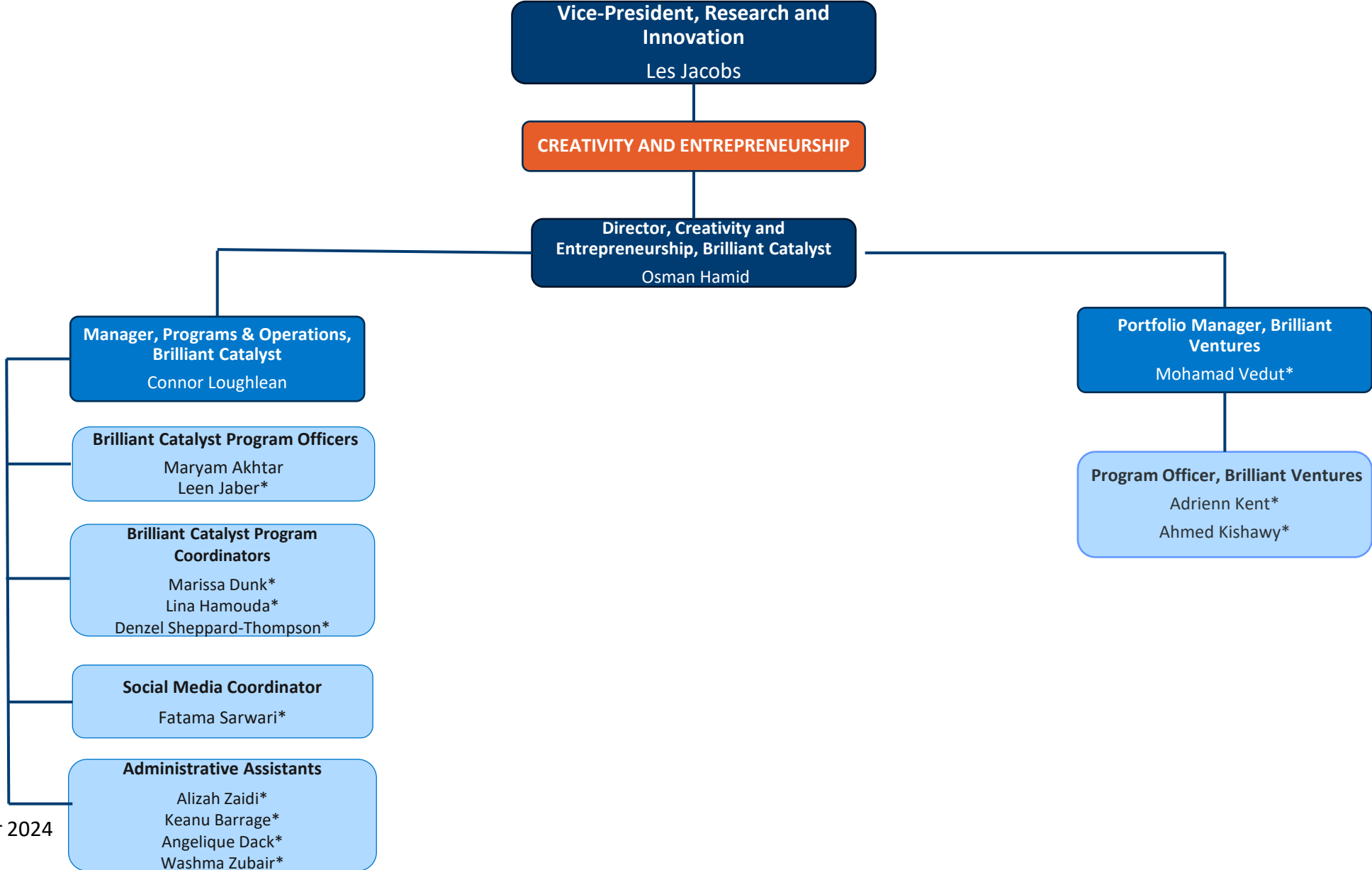

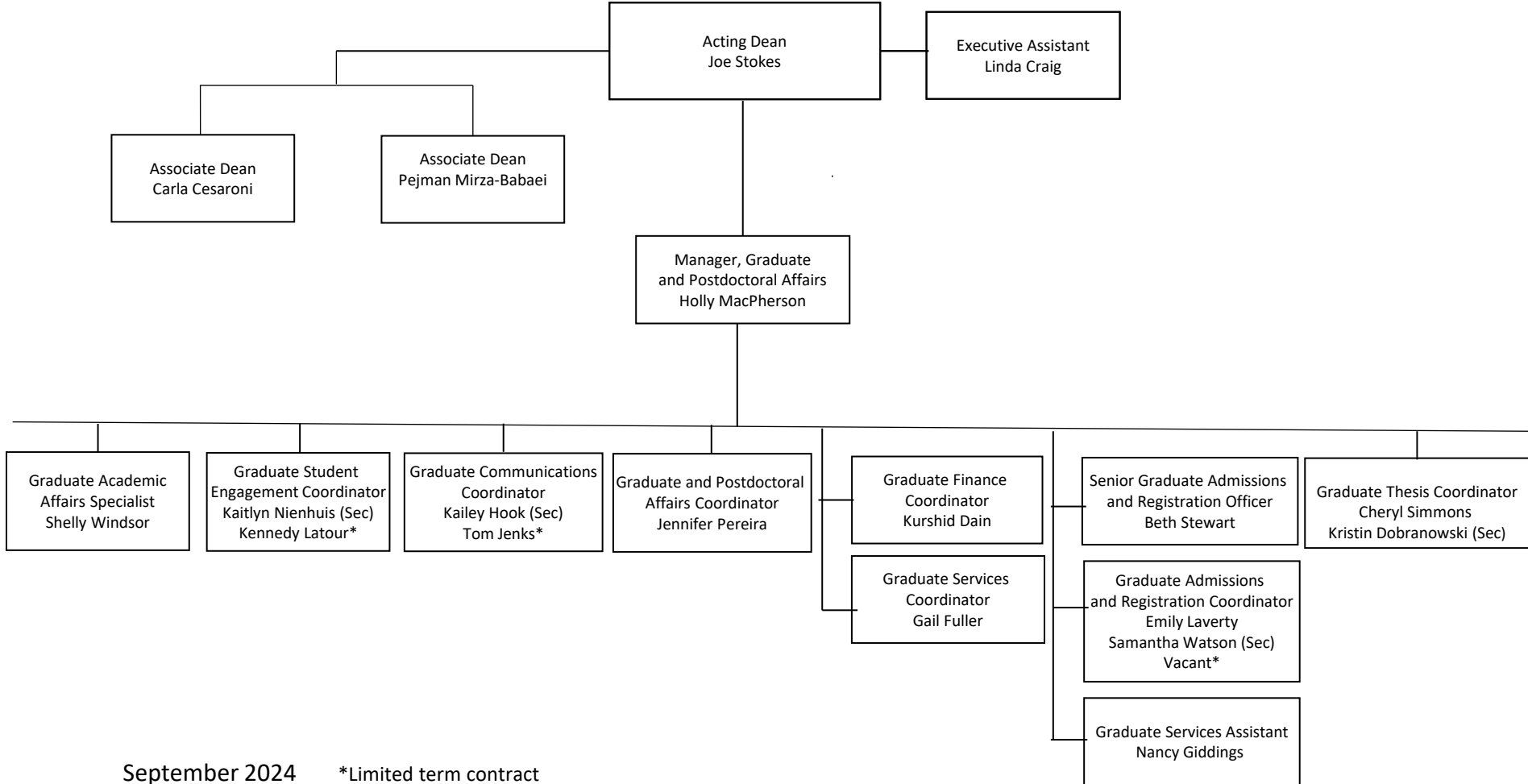

September 2024

*Limited term contract

General Counsel's Office

